

Variable speed drives Altivar Process

Catalog

May 2014



How can you fit a 6000-page catalog in your pocket ?

Schneider Electric provides you with the complete set of industrial automation catalogs all on a handy USB key for PC or in an application for tablets



Digi-Cat, a handy USB key for PC



- > Convenient to carry
- > Always up-to-date
- > Environmentally friendly
- > Easy-to-share format

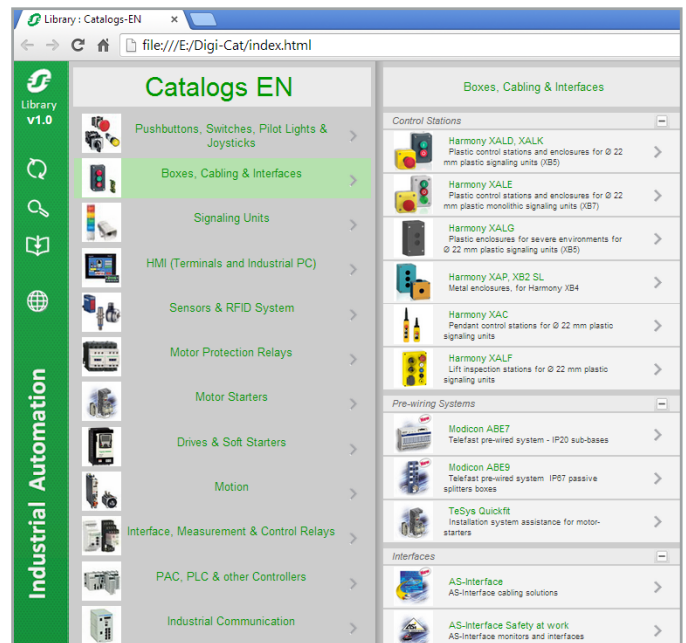

Contact your local representative to get your own Digi-Cat



e-Library, the app for tablets

If you have an iPad®:

- > Go to the App Store and search for e-Library
- > or scan the QR code



If you have an Android tablet:

- > Go to the Google Play Store™ and search for eLibrary
- > or scan the QR code

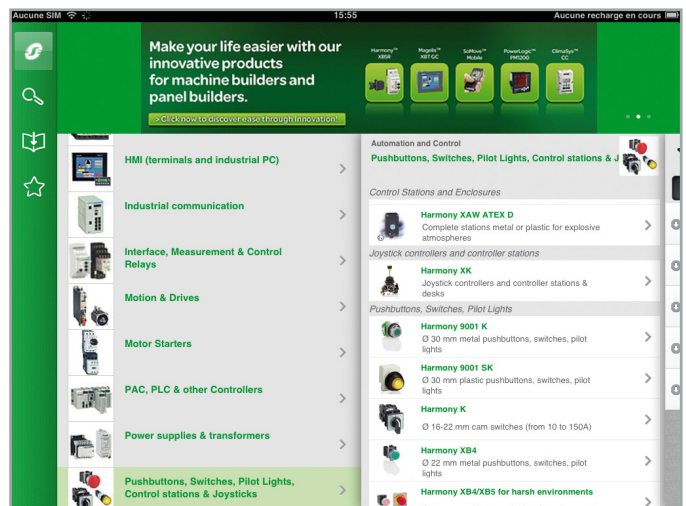

Contents

Altivar Process drives

Selection guide page 2

■ Presentation	page 4
■ References	page 12
□ 200...240 V 50/60 Hz supply, IP 21.....	page 12
□ 380...480 V 50/60 Hz supply	page 13
- IP 21, with integrated category C2 or C3 EMC filter	page 13
- IP 55, with integrated category C2 or C3 EMC filter	page 14
- IP 55, with Vario disconnect switch and integrated category C2 or C3 EMC filter.....	page 15
□ Replacement parts	page 15
■ Configuration and runtime tools	page 16
□ Remote graphic display terminal.....	page 16
□ Accessories	page 17
□ Web server	page 18
□ DTM libraries and SoMove setup software	page 19

Drive/option combinations

■ **Compatibility table**

Options

■ I/O expansion cards	page 22
■ Communication buses and networks	page 24
□ Integrated ports	page 26
□ EtherNet/IP and Modbus TCP.....	page 27
□ CANopen.....	page 28
□ ProfiNet	page 30
□ Profibus DP V1	page 30
□ DeviceNet.....	page 31
■ Passive filters	page 32
■ EMC filters	page 34
■ Output filters	page 36
□ dv/dt filters	page 36
□ Sinus filters	page 37
■ Motor starters	page 38
□ 200...240 V 50/60 Hz supply	page 38
□ 380...415 V 50/60 Hz supply	page 39
□ 440 V 50/60 Hz supply	page 39

Dimensions

■ Drives	page 40
■ Options	page 42

Index

■ **Product reference index**..... page 44

IP 21 or IP 55 variable speed drives for synchronous and asynchronous motors

Market segments

- Water & wastewater
- Oil & gas
- Mining, minerals & metals
- Food & beverage



Degree of protection	
Power range for 50...60 Hz line supply (kW/HP)	
	Three-phase: 200...240 V (kW/HP)
	Three-phase: 380...480 V (kW/HP)
Drive	Output frequency
	Control type
Functions	Asynchronous motor
	Synchronous motor
Advanced functions	
Integrated safety function	
Number of preset speeds	
Number of integrated I/O	Analog inputs
	Logic inputs
	Analog outputs
	Relay outputs
I/O expansion cards (optional)	Safety function inputs
	Analog inputs
	Logic inputs
Relay output card (optional)	Logic outputs
	Relay outputs
Communication	Integrated
	Option cards
Configuration and runtime tools	
Standards and certifications	
References	
Page	

IP 21	
11...90/15...125	
11...45/15...60	
15...90/20...125	
0.1...500 Hz	
Standard constant torque, standard variable torque, optimized torque mode	
PM (permanent magnet) motor	
<ul style="list-style-type: none"> ■ Accurate measurement for monitoring process energy consumption (deviation < 5%) ■ Process energy drift detection ■ Embedded Ethernet with direct access to system configuration and monitoring ■ Integration of actual pump curves to optimize the process operating point ■ Optimized pump monitoring based on actual operating point ■ Sensorless estimated flow rate ■ Measurements expressed in working units (e.g.: m³/h, kWh/m³) ■ Limitation of overvoltage at the motor terminals ■ Contextual access to technical documentation through dynamic QR code ■ Continuous and historical real-time measurements with customizable dashboards ■ Predictive and preventive maintenance tracking functions (e.g.: temperatures with PT100/1000 probe, fan monitoring) 	
1: STO (Safe Torque Off) SIL3	
16	
3: configurable as voltage (0...10 V) or current (0-20 mA), including 2 for probes (PTC, PT100, PT1000, or KTY84)	
6	
2: configurable as voltage (0...10 V) or current (0-20 mA)	
3	
2: for safety function STO	
2 differential analog inputs configurable via software as current (0-20 mA/ 4-20 mA), or for PTC, PT100, or PT1000 probe (2- or 3-wire)	
6: voltage 24 V $\overline{\text{---}}$ (positive or negative logic)	
2: assignable	
3: NO contacts	
Modbus/TCP, Modbus serial link	
EtherNet/IP and Modbus/TCP Dual port, CANopen Daisy Chain RJ45, Sub-D and screw terminals, ProfiNet, Profibus DP V1 and DeviceNet	
Remote graphic display terminal, embedded web server, DTM (Device Type Manager), SoMove software	
UL 508C, EN/IEC 61800-3, EN/IEC 61800-3 environment 1 category C2, EN/IEC 61800-3 environment 2 category C3, EN/IEC 61800-5-1, IEC 61000-3-12, IEC 60721-3, IEC 61508	
ATV630●●●●●	
12	

- Water & wastewater
- Oil & gas
- Mining, minerals & metals
- Food & beverage



IP 55		IP 55 with Vario disconnect switch	
15...90/20...125		-	
-		-	
15...90/20...125		-	
0.1...500 Hz		-	
Standard constant torque, standard variable torque, optimized torque mode		-	
PM (permanent magnet) motor		-	
<ul style="list-style-type: none"> ■ Accurate measurement for monitoring process energy consumption (deviation < 5%) ■ Process energy drift detection ■ Embedded Ethernet with direct access to system configuration and monitoring ■ Integration of actual pump curves to optimize the process operating point ■ Optimized pump monitoring based on actual operating point ■ Sensorless estimated flow rate ■ Measurements expressed in working units (e.g.: m³/h, kWh/m³) ■ Limitation of overvoltage at the motor terminals ■ Contextual access to technical documentation through dynamic QR code ■ Continuous and historical real-time measurements with customizable dashboards ■ Predictive and preventive maintenance tracking functions (e.g.: temperatures with PT100/1000 probe, fan monitoring) 		-	
1: STO (Safe Torque Off) SIL3		-	
16		-	
3: configurable as voltage (0...10 V) or current (0-20 mA), including 2 for probes (PTC, PT100, PT1000, or KTY84)		-	
6		-	
2: configurable as voltage (0...10 V) or current (0-20 mA)		-	
3		-	
2: for safety function STO		-	
2 differential analog inputs configurable via software as current (0-20 mA/ 4-20 mA), or for PTC, PT100, or PT1000 probe (2- or 3-wire)		-	
6: voltage 24 V $\overline{\text{---}}$ (positive or negative logic)		-	
2: assignable		-	
3: NO contacts		-	
Modbus/TCP, Modbus serial link		-	
EtherNet/IP and Modbus/TCP Dual port, CANopen Daisy Chain RJ45, Sub-D and screw terminals, ProfiNet, Profibus DP V1 and DeviceNet		-	
Remote graphic display terminal, embedded web server, DTM (Device Type Manager), SoMove software		-	
UL 508C, EN/IEC 61800-3, EN/IEC 61800-3 environment 1 category C2, EN/IEC 61800-3 environment 2 category C3, EN/IEC 61800-5-1, IEC 61000-3-12, IEC 60721-3, IEC 61508		-	
ATV650●●●●●		ATV650●●●●●E	
14		15	



Altivar Process range

Process

The Altivar Process drive is an IP 21 or IP 55 frequency inverter for three-phase synchronous and asynchronous motors, specially designed for the following market segments:

- Water & wastewater
- Oil & gas
- Mining, minerals & metals
- Food & beverage



Water & wastewater applications

- pumping
- drilling
- suction
- dosing
- odor control
- ventilation
- gas compression
- sludge removal

Use

- pumping station and storage tank
- irrigation
- treatment plant
- desalination plant
- storage and booster station
- housing
- wastewater lift station
- wastewater treatment
- discharge back into the environment, land application



Process (continued)

Oil & gas applications

- Hydrocarbon production:
 - drilling
 - offshore and onshore extraction
 - water treatment and re-injection
 - crude oil storage
 - separation
 - pipeline pumping
 - storage
 - refining
 - DOF (digital oil field)

Use

- Pumps:
 - submersible
 - hydraulic
 - pipeline
 - reverse flow
 - water injection
 - kerosene
- regasification compressors
- Refining:
 - fans
 - compressors



Mining, minerals & metals applications

- Flotation and thickening
- Rinsing and filtration
- Mine shaft pumping
- Preheater fan
- Waste gas evacuation
- Cooling fan
- Separator for vertical roller mill
- Storage and loading
- Water supply
- Pumping
- Drying fan

Use

- Farming:
 - conveyors
 - grinders
 - mixers
 - centrifuges
 - pumps



Food & beverage applications

- Pumping
- Drying fans

Use

- Farming:
 - conveyors
 - grinders
 - mixers
 - centrifuges
 - pumps

Presentation of the offer

Altivar Process drives can help improve equipment performance and reduce exploitation costs by optimizing energy consumption and user comfort.

They provide integrated safety and automation functions that meet the requirements of the most demanding applications.

They also have various optional communication cards available for seamless integration into the main automation architectures.

Altivar Process drives feature numerous configurable I/O as standard to facilitate adaptation to specific applications.

They offer a plug & play solution, whereby parameters are preset in the factory to the desired configuration, to help save process control and operating time.

Altivar Process drives can also be supplied as a customized solution developed by Schneider Electric based on customer specifications.

Rugged

Altivar Process drives are designed to adapt to significant levels of thermal stress and to the harshest environments.

- Operating temperature (for continuous monitoring)
 - Mounted in enclosure:
 - mounted singly or side-by-side: $-15...+50\text{ }^{\circ}\text{C}/+5...122\text{ }^{\circ}\text{F}$, $50...60\text{ }^{\circ}\text{C}/122...140\text{ }^{\circ}\text{F}$ with derating
 - option to mount the power section separately (patent No. RUE-2192 "flange-mounting kit")
 - Wall-mounted:
 - plant room: $50\text{ }^{\circ}\text{C}/122\text{ }^{\circ}\text{F}$ (max.)
 - harsh environment: $40\text{ }^{\circ}\text{C}/104\text{ }^{\circ}\text{F}$ (max.)
- Storage and transport temperature: $-40...+70\text{ }^{\circ}\text{C}/-40...+158\text{ }^{\circ}\text{F}$
- Operating altitude:
 - $0...1,000\text{ m}/0...3,281\text{ ft}$ without derating
 - $1,000...4,800\text{ m}/3,281...15,748\text{ ft}$ with derating of 1% per 100 m/328 ft
- Withstand to harsh environments:
 - chemical class 3C3 conforming to IEC/EN 60721
 - mechanical class 3S3 conforming to IEC/EN 60721
 - electronic cards with protective coating
- Protection to suit requirements:
 - IP 21/UL type 1 for wall-mounting and mounting in enclosure
 - IP 55/UL type 12 for custom mounting, with protection against dust and water jets

Energy

Altivar Process drives help to optimize power consumption by reducing the rms input current for the same load.

- Standard offer:
 - THDI $\leq 44\%$ at 100% load
 - THDI $\leq 48\%$ for 80 to 100% load, which corresponds to typical use to maintain the power factor
- Low harmonic offer compatible with standard IEEE 519
- Low power:

Depending on the model, Altivar Process drives can also reduce power consumption by up to 60% on each stop by disabling the power section, the fans, the backlight on the graphic display terminal, etc. This "stop and go" function is automatic on each stop and requires no extra investment (no line contactor or 24 V power supply required).

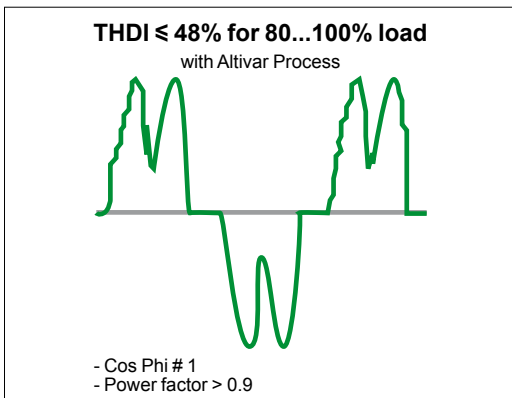

THDI of Altivar Process drives

Presentation of the offer (continued)

Environment

Altivar Process drives have been designed to meet the requirements of environmental protection directives and regulations:

- RoHS 2 (1)
- REACH (2) + Substitute It Now solution (halogen-free wiring and plastics)
- PEP (Product Environmental Profile) eco-passport program for reducing the carbon footprint and conserving raw materials
- EoLI (End of Life Instruction) (3)
- more than 70% recyclable materials (new ruling)
- Efficient energy management: 30% reduction in consumption

Electromagnetic compatibility (EMC)

Compliance with electromagnetic compatibility requirements has been incorporated into the design of the drive, which simplifies installation and provides an economical means of helping to ensure equipment meets CE marking requirements.

Altivar Process drives have a category C2 or C3 EMC filter, except ATV630D11M3...D45M3 models which can take an additional filter to meet more stringent requirements (see page 34).

Installation/Maintenance

Altivar Process drives are ergonomically designed to adapt to any type of installation:

- Products, systems or integrated in iMCC
- IP 21, UL type 1; IP 55, UL type 12
- Easy installation of products and systems:
 - cable entry equipped with Romex cable glands to maintain an EMC connection for the power and control cable
 - color code for connections to the display terminal and control terminals
 - long cable: up to 150 m with category C3 EMC filter
- Asynchronous or synchronous drive in open loop for 0.1...500 Hz output frequency
- Special motors: submersible and tapered rotor motors
- Lower maintenance costs due to drive's ergonomic design:
 - fans can be replaced in less than 5 minutes
 - no maintenance tool required
 - limited number of parts
- Embedded web server:
 - compatible process elements for easier implementation
 - direct worldwide access to monitoring and maintenance functions:
 - reading values
 - modifying data
 - configuring parameters
 - changing controller status

(1) European directive 2002/95/EC Restriction Of Hazardous Substances (applicable in 2016)

(2) European regulation No. 1907/2006

(3) According to IEC 62635 Guidelines

Integrated functions

Altivar Process drives include numerous advanced functions for the more complex applications in each market segment.

Advanced functions

- Accurate measurement for monitoring process energy consumption (deviation < 5%)
- Process energy drift detection
- Embedded Ethernet with direct access to system configuration and monitoring
- Integration of actual pump curves to optimize the process operating point
- Optimized pump monitoring based on actual operating point
- Sensorless estimated flow rate
- Measurements expressed in working units (e.g.: m³/h, kWh/m³)
- Limitation of overvoltage at the motor terminals
- Contextual access to technical documentation through dynamic QR code
- Continuous and historical real-time measurements with customizable dashboards
- Predictive and preventive maintenance tracking functions (e.g.: temperatures with PT100/1000 probe, fan monitoring)

Power measurement function

Altivar Process drives integrate a power measurement function accurate to within 5%, based on measurement of the motor voltage and the power supply:

- Process drift detection for reliability throughout entire service life
- Useful process performance information provided by comparing the energy used with the energy produced:
- Typical KPIs:
 - specific energy consumption
 - kWh/m³
 - kWh/mWc/m³

Users are therefore able to monitor and analyse input power, energy produced, and the KPIs directly from the drive or from the process management system.

Safety and monitoring functions

The Safety function STO and numerous monitoring functions are provided to help to protect personnel and equipment.

- Advantages:
 - time savings in terms of installation design and compliance
 - fewer components and cables
 - optimum space
 - simplified setup of machines
 - improved maintenance performance; limited machine intervention time and installation downtime
 - optimized conditions for maintenance operations
- Conformity to standards EN/IEC 61508, EN/ISO 13849, IEC 61800-5-2
- Integrated STO (Safe Torque Off) function, SIL3/Plc
- Monitoring function to help to protect against premature wear:
 - monitoring of pumping cycles
 - start-stop of centrifugal pumps
 - monitoring of start cycles (number of starts per hour)
 - monitoring function to help to protect against water hammer
 - cleaning of pumps by reversing the flow (anti-clogging)

Integration

Communication protocols

- Modbus/TCP
 - data-process transfers over industrial Ethernet networks via integrated Ethernet port:
 - read/write data on Modbus network
 - diagnostic and fieldbus management functions
- Modbus serial link
 - connection of configuration and runtime tools via 2 integrated ports
- Ethernet services: SNMP, SNTP, BootP & DHCP, IPv6

Integration in Ethernet network

- FDT/DTM technology (see page 19):
- drive configuration, diagnostics, and control using Unity Pro software

Integrated services

Altivar Process drives feature integrated services to achieve optimum time savings:

- Simplified communication
 - Ethernet port with embedded web server
- Energy management (integrated power measurement)
- dynamic predictive maintenance
- 3 QR codes:
 - 1: access to the Customer Care Center application and product data sheet
 - 2: direct access to the description of the functions
 - 3: QR code generated in the event of a detected error (red screen): identification of the detected error, probable causes and remedies

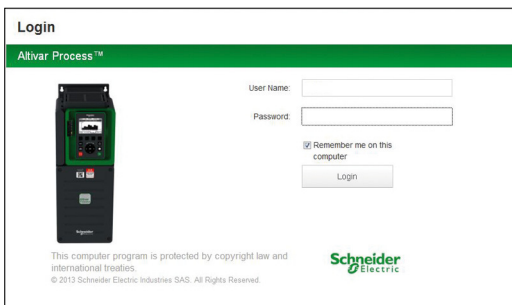

Embedded web server login screen

Configuration and runtime tools

- Remote graphic terminal (see 16):
 - drive control, adjustment, and configuration
 - display of current values (motor, I/O, etc.)
 - configuration storage and download
 - duplication of one drive configuration on another drive from a PC or another drive
 - remote use by means of appropriate accessories (see page 17)
 - connection to several drives using multidrop link components (see page 17)
- Embedded web server (see page 18):
 - easily accessible from any PC, iPhone, iPad, Android system, and major web browsers
 - network diagnostics in real time
 - read/write values
- SoMove software (see page 19):
 - advanced functions for configuration, setup, and maintenance of Altivar Process drives



ATV630D11M3...D45M3, ATV630D15N4...D90N4



ATV650D15N4...D90N4



ATV650D15N4E...D90N4E

Extensive offer

The Altivar Process offer covers motor power ratings from 11 to 90 kW for three-phase voltages between 200...240 V and 380...480 V.

Three-phase power supply	Motor power	Degree of protection	Reference
200...240 V	11 kW...45 kW 15...60 HP	IP 21 UL type 1	ATV630D11M3...D45M3
380...480 V	15 kW...90 kW 20...125 HP	IP 21 UL type 1	ATV630D15N4...D90N4
		IP 55 UL type 12	ATV650D15N4...D90N4
		IP 55 UL type 12	ATV650D15N4E...D90N4E (1)

Accessories and options

Altivar Process drives are designed to take numerous accessories and options to increase their functionality.

Accessories

- Drive:
 - fan kit (see page 15)
- Graphic display terminal:
 - remote mounting kit for mounting on enclosure door (see page 17)
 - multidrop connection accessories for connecting several drives to the RJ45 terminal port (see page 17)

(1) Integrated disconnect switch

Accessories and options (continued)

Options

- Cards (see page 22):
 - I/O expansion:
 - 2 analog inputs
 - 6 logic inputs
 - 2 logic outputs
 - relay output:
 - 3 NO contacts
 - communication:
 - EtherNet/IP and Modbus TCP dual port
 - CANopen bus: RJ45 daisy chain, SUB-D, 5-way screw terminals
 - ProfiNet bus
 - Profibus DP V1 bus
 - DeviceNet bus
- Passive filters (see page 32)
- Additional EMC input filters to reduce conducted emissions on the line supply (see 34)
- Output filters:
 - dv/dt filters (see page 36)
 - sinus filters (see page 37)

Motor starters

Schneider Electric offers combinations of circuit breakers and contactors to be able to use Altivar Process drives in optimum conditions (see page 38).

Variable speed drives

Altivar Process

Supply voltage 200...240 V 50/60 Hz



ATV630D11M3



ATV630D15M3



ATV630D30M3

IP 21 three-phase 200...240 V drives ⁽¹⁾										
Motor			Line supply				Altivar Process			
Power indicated on rating plate ⁽²⁾			Line current ⁽³⁾		Apparent power	Max. prospective line Isc	Max. continuous current ⁽²⁾	Max. transient current for 60 s	Reference ^{(1) (6)}	Weight
			200 V	240 V	240 V					
ND:	Normal duty ⁽⁴⁾									
HD:	Heavy duty ⁽⁵⁾									
	kW	HP	A	A	kVA	kA	A	A		kg/lb
THDI ≤ 44% at 100% load										
ND	11	15	39.3	32.9	13.7	50	46.8	51.5	ATV630D11M3	13.800/ 30.424
HD	7.5	10	27.2	23.1	9.6	50	32.7	49.1		
ND	15	20	52.6	45.5	18.9	50	63.4	69.7	ATV630D15M3	27.300/ 60.186
HD	11	15	40.1	34.3	14.3	50	46.8	70.2		
ND	18.5	25	66.7	54.5	22.7	50	78.4	86.2	ATV630D18M3	27.300/ 60.186
HD	15	20	53.1	44.9	18.7	50	63.4	95.1		
ND	22	30	76.0	64.3	26.7	50	92.6	101.9	ATV630D22M3	27.300/ 60.186
HD	18.5	25	64.8	54.5	22.7	50	78.4	117.6		
ND	30	40	104.7	88.6	36.8	50	123	135.3	ATV630D30M3	56.600/ 124.781
HD	22	30	78.3	67.1	27.9	50	92.6	138.9		
ND	37	50	128.0	107.8	44.8	50	149	163.9	ATV630D37M3	56.600/ 124.781
HD	30	40	104.7	88.6	36.8	50	123	184.5		
ND	45	60	155.1	130.4	54.2	50	176	193.6	ATV630D45M3	56.600/ 124.781
HD	37	50	128.5	108.5	45.1	50	149	223.5		

(1) Altivar Process **ATV630D11M3...D45M3** drives have been designed without an EMC filter. An additional filter can be added to help meet more stringent requirements and reduce electromagnetic emissions.

(2) These values are given for a nominal switching frequency of 4 kHz up to **ATV630D22M3**, or 2.5 kHz for **ATV630D30M3...D45M3** for use in continuous operation.

The switching frequency is adjustable from 1...16 kHz for all ratings.

Above 2.5 or 4 kHz (depending on the rating), the drive will automatically reduce the switching frequency in the event of an excessive temperature rise. For continuous operation above the nominal switching frequency, derate the nominal drive current (see the derating curves on our website www.schneider-electric.com).

(3) Typical value for the indicated motor power and for the maximum prospective line Isc.

(4) Values given for applications requiring a slight overload (up to 110%).

(5) Values given for applications requiring a significant overload (up to 150%).

(6) The drives can operate on a single-phase power supply. In this case, for the same drive rating, motor power is divided by 3. E.g. **ATV630D11M3** for a 3 kW motor.

Note: Consult the summary tables of possible drive, option, and accessory combinations (see page 20).



ATV630D15N4



ATV630D30N4



ATV630D55N4

IP 21 three-phase 380...480 V drives with integrated category C2 or C3 EMC filter											
Motor			Line supply				Altivar Process				
Power indicated on rating plate (1)			Line current (2)		Apparent power	Max. prospective line Isc	Max. continuous current (1)	Max. transient current for 60 s	Reference (1) (5)	Weight	
			380 V	480 V							
ND:	Normal duty (3)										
HD:	Heavy duty (4)										
	kW	HP	A	A	kVA	kA	A	A			kg/lb
THDI ≤ 44% at 100% load											
ND	15	20	27	23.3	19.4	50	31.7	34.9		ATV630D15N4	13.600/ 29.983
HD	11	15	20.6	18.1	15.0	50	23.5	35.3			
ND	18.5	25	33.4	28.9	24	50	39.2	43.1		ATV630D18N4	14.200/ 31.306
HD	15	20	27.7	24.4	20.3	50	31.7	47.6			
ND	22	30	39.6	34.4	28.6	50	46.3	50.9		ATV630D22N4	14.300/ 31.526
HD	18.5	25	34.1	29.9	24.9	50	39.2	58.8			
ND	30	40	53.3	45.9	38.2	50	61.5	67.7		ATV630D30N4	28.000/ 61.729
HD	22	30	40.5	35.8	29.8	50	46.3	69.5			
ND	37	50	66.2	57.3	47.6	50	74.5	82		ATV630D37N4	28.200/ 62.170
HD	30	40	54.8	48.3	40.2	50	61.5	92.3			
ND	45	60	79.8	69.1	57.4	50	88	96.8		ATV630D45N4	28.700/ 63.273
HD	37	50	67.1	59.0	49.1	50	74.5	111.8			
ND	55	75	97.2	84.2	70	50	106	116.6		ATV630D55N4	56.500/ 124.561
HD	45	60	81.4	71.8	59.7	50	88	132.0			
ND	75	100	131.3	112.7	93.7	50	145	159.5		ATV630D75N4	58.000/ 127.868
HD	55	75	98.9	86.9	72.2	50	106	159.0			
ND	90	125	156.2	135.8	112.9	50	173	190.3		ATV630D90N4	58.500/ 128.970
HD	75	100	134.3	118.1	98.2	50	145	217.5			

(1) These values are given for a nominal switching frequency of 4 kHz up to ATV630D45N4, or 2.5 kHz for ATV630D55N4...D90N4 for use in continuous operation.

The switching frequency is adjustable from 1...16 kHz for all ratings.

Above 2.5 or 4 kHz (depending on the rating), the drive will automatically reduce the switching frequency in the event of an excessive temperature rise. For continuous operation above the nominal switching frequency, derate the nominal drive current (see the derating curves on our website www.schneider-electric.com).

(2) Typical value for the indicated motor power and for the maximum prospective line Isc.

(3) Values given for applications requiring a slight overload (up to 110%).

(4) Values given for applications requiring a significant overload (up to 150%).

(5) The drives can operate on a single-phase power supply. In this case, for the same drive rating, motor power is divided by 3. E.g. ATV630D18N4 for a 4 kW motor.

Note: Consult the summary tables of possible drive, option, and accessory combinations (see page 20).

Variable speed drives

Altivar Process

Supply voltage 380...480 V 50/60 Hz



ATV650D15N4



ATV650D30N4



ATV650D55N4

IP 55 three-phase 380...480 V drives with integrated category C2 or C3 EMC filter ⁽¹⁾										
Motor		Line supply					Altivar Process			
Power indicated on rating plate ⁽²⁾		Line current ⁽³⁾		Apparent power	Max. prospective line I _{sc}	Max. continuous current ⁽²⁾	Max. transient current for 60 s	Reference ⁽¹⁾	Weight	
		380 V	480 V							380 V
ND:	Normal duty ⁽⁴⁾									
HD:	Heavy duty ⁽⁵⁾									
	kW	HP	A	A	kVA	kA	A	A		kg/lb
THDI ≤ 44% at 100% load										
ND	15	20	27	23.3	19.4	50	31.7	34.9	ATV650D15N4	–
HD	11	15	20.6	18.1	15	50	23.5	35.3		
ND	18.5	25	33.4	28.9	24	50	39.2	43.1	ATV650D18N4	–
HD	15	20	27.7	24.4	20.3	50	31.7	47.6		
ND	22	30	39.6	34.4	28.6	50	46.3	50.9	ATV650D22N4	–
HD	18.5	25	34.1	29.9	24.9	50	39.2	58.8		
ND	30	40	53.3	45.9	38.2	50	59	64.9	ATV650D30N4	–
HD	22	30	40.5	35.8	29.8	50	46.3	69.5		
ND	37	50	66.2	57.3	47.6	50	72	79.2	ATV650D37N4	–
HD	30	40	54.8	48.3	40.2	50	59	88.5		
ND	45	60	79.8	69.1	57.4	50	87	95.7	ATV650D45N4	–
HD	37	50	67.1	59	49.1	50	72	108		
ND	55	75	97.2	84.2	70	50	106	116.6	ATV650D55N4	–
HD	45	60	81.4	71.8	59.7	50	87	130.5		
ND	75	100	131.3	112.7	93.7	50	145	159.5	ATV650D75N4	–
HD	55	75	98.9	86.9	72.2	50	106	159		
ND	90	125	156.2	135.8	112.9	50	173	190.3	ATV650D90N4	–
HD	75	100	134.3	118.1	98.2	50	145	217.5		

(1) Supplied with cable gland.

(2) These values are given for a nominal switching frequency of 4 kHz up to **ATV650D22N4**, or 2.5 kHz for **ATV650D30N4...D90N4** for use in continuous operation.

The switching frequency is adjustable from 1...16 kHz for all ratings.

Above 2.5 or 4 kHz (depending on the rating), the drive will automatically reduce the switching frequency in the event of an excessive temperature rise. For continuous operation above the nominal switching frequency, derate the nominal drive current (see the derating curves on our website www.schneider-electric.com).

(3) Typical value for the indicated motor power and for the maximum prospective line I_{sc}.

(4) Values given for applications requiring a slight overload (up to 110%).

(5) Values given for applications requiring a significant overload (up to 150%).

Note: Consult the summary tables of possible drive, option, and accessory combinations (see page 20).



ATV650D15N4E



ATV650D30N4E



ATV650D55N4E

IP 55 three-phase 380...480 V drives with Vario disconnect switch and integrated category C2 or C3 EMC filter (1)

Motor Power indicated on rating plate (2)	Line supply						Altivar Process		Reference (1)	Weight
	Line current (3)		Apparent power	Max. prospective line Isc	Max. continuous current (2)	Max. transient current for 60 s	Reference (1)	Weight		
	380 V	480 V	380 V							
ND: Normal duty (4)										
HD: Heavy duty (5)										
	kW	HP	A	A	kVA	kA	A	A	kg/lb	
THDI ≤ 44% at 100% load										
ND	15	20	27	23.3	19.4	50	31.7	34.9	ATV650D15N4E	–
HD	11	15	20.6	18.1	15	50	23.5	35.3		
ND	18.5	25	33.4	28.9	24	50	39.2	43.1	ATV650D18N4E	–
HD	15	20	27.7	24.4	20.3	50	31.7	47.6		
ND	22	30	39.6	34.4	28.6	50	46.3	50.9	ATV650D22N4E	–
HD	18.5	25	34.1	29.9	24.9	50	39.2	58.8		
ND	30	40	53.3	45.9	38.2	50	59	64.9	ATV650D30N4E	–
HD	22	30	40.5	35.8	29.8	50	46.3	69.5		
ND	37	50	66.2	57.3	47.6	50	72	79.2	ATV650D37N4E	–
HD	30	40	54.8	48.3	40.2	50	59	88.5		
ND	45	60	79.8	69.1	57.4	50	87	95.7	ATV650D45N4E	–
HD	37	50	67.1	59	49.1	50	72	108		
ND	55	75	97.2	84.2	70	50	106	116.6	ATV650D55N4E	–
HD	45	60	81.4	71.8	59.7	50	87	130.5		
ND	75	100	131.3	112.7	93.7	50	145	159.5	ATV650D75N4E	–
HD	55	75	98.9	86.9	72.2	50	106	159		
ND	90	125	156.2	135.8	112.9	50	173	190.3	ATV650D90N4E	–
HD	75	100	134.3	118.1	98.2	50	145	217.5		

Replacement parts

Description	For drives	Reference	Weight kg/lb
Fan kit for IP 21 drives			
Fan, bracket, instruction sheet	ATV630D11M3, ATV630D15N4...D22N4	VX5VPS3001	–
	ATV630D15M3...D22M3, ATV630D30N4...D45N4	VX5VPS4001	–
	ATV630D30M3...D45M3, ATV630D55N4...D90N4	VX5VPS5001	–
Fan kit for IP 55 drives			
Fan, bracket, instruction sheet	ATV650D15N4...D22N4, ATV650D15N4E...D22N4E	VX5VP50A001	–
	ATV650D30N4...D90N4, ATV650D30N4E...D90N4E	VX5VP50BC001	–

(1) Supplied with cable gland.

(2) These values are given for a nominal switching frequency of 4 kHz up to **ATV650D22N4E**, or 2.5 kHz for **ATV650D30N4E...D90N4E** for use in continuous operation.

The switching frequency is adjustable from 1...16 kHz for all ratings.

Above 2.5 or 4 kHz (depending on the rating), the drive will automatically reduce the switching frequency in the event of an excessive temperature rise. For continuous operation above the nominal switching frequency, derate the nominal drive current (see the derating curves on our website www.schneider-electric.com).

(3) Typical value for the indicated motor power and for the maximum prospective line Isc.

(4) Values given for applications requiring a slight overload (up to 110%).

(5) Values given for applications requiring a significant overload (up to 150%).

Note: Consult the summary tables of possible drive, option, and accessory combinations (see page 20).



Remote graphic display terminal (example shows dynamic pump operation in relation to its optimum operation)



Detected fault: the screen's red backlight is activated automatically



Embedded dynamic QR codes for contextual, instantaneous access to online help



Scanning the QR code from a smartphone or tablet

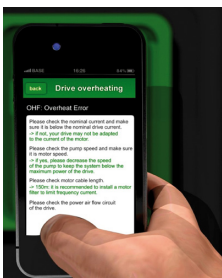

Instant access to online help

Remote graphic display terminal (supplied with the drive)

This terminal can be:

- Connected and mounted on the front of the drive
- Connected and mounted on an enclosure door using a remote mounting accessory
- Connected to a PC to exchange files via a Mini USB/USB connection (1)
- Connected to several drives in multidrop mode (see page 17)

This terminal is used to:

- Control, adjust, and configure the drive
- Display current values (motor, I/O, and process data)
- Display graphic dashboards such as the energy consumption monitoring dashboard
- Store and download configurations (several configuration files can be stored in the 16 MB memory)
- Duplicate the configuration of one powered-up drive on another powered-up drive
- Copy configurations from a PC or drive and duplicate them on another drive (the drives must be powered on for the duration of the duplication operations)

Other characteristics:

- 23 integrated languages (complete alphabets) covering the majority of countries around the world (other languages can be added; please consult our website www.schneider-electric.com)
- 2-color backlit display (white and red); if an error is detected, the red backlight is activated automatically (function can be disabled)
- Operating range: -15...50 °C/+5...122 °F
- IP 65 protection
- Trend curves: graphic display of changes over time in monitoring variables, energy data, and process data
- Graphic display of a pump's dynamic operation in relation to its optimum operation
- Embedded dynamic QR codes for providing contextual, instantaneous access to online help (diagnostics and settings, etc.) using a smartphone or tablet
- Real-time clock with backup battery for providing data acquisition and event timestamping functions even when the drive is stopped

Description

Display:

- 8 lines, 240 x 160 pixels
- Displays bar charts, gauges, and trend charts
- 4 function keys to facilitate navigation and provide contextual links for enabling functions
- "STOP/RESET" button: local control of motor stop command/clearing detected faults
- "RUN" button: local control of motor run command
- Navigation buttons:
 - OK button: saves the current value (ENT)
 - turn ±: increases or decreases the value, goes to the next or previous line
 - "ESC" button: aborts a value, parameter, or menu to return to the previous selection
 - home: root menu
 - information (i): contextual help

References

Description	Reference	Weight kg/ lb
Remote graphic display terminal	VW3A1111	0.200/ 0.441

(1) For portable use of the graphic display terminal only



Remote mounting kit for mounting graphic display terminal on enclosure door (front panel)

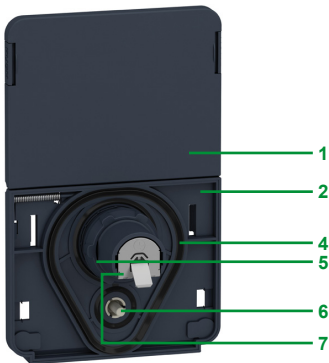

Remote mounting kit for graphic display terminal (rear panel)

Accessories for remote graphic display terminal

■ Remote mounting kit for mounting on an enclosure door with IP 65 degree of protection as standard

The kit comprises:

- Tightening tool (also sold separately under the reference ZB5AZ905)

- 1 Cover plate to maintain IP 65 protection when there is no terminal connected
- 2 Mounting plate
- 3 RJ45 port for the graphic display terminal
- 4 Seal
- 5 Fixing nut
- 6 Anti-rotation pin
- 7 RJ45 port for connecting the remote-mounting cordset

Cordsets must be ordered separately depending on the length required.

Drilling a hole with a standard $\varnothing 22$ tool, as used for a pushbutton, allows the unit to be mounted without needing a cut-out in the enclosure ($\varnothing 22.5$ mm/ $\varnothing 0.89$ in. drill hole).

References

Description	Length m/ ft	IP degree of protection	Reference	Weight kg/ lb
Remote mounting kit Order with remote-mounting cordset VW3A1104R●●●	–	65	VW3A1112	–
Tightening tool for remote mounting kit	–	–	ZB5AZ905	0.016/ 0.035
Remote-mounting cordset equipped with 2 RJ45 connectors	1/ 3.28 3/ 9.84 5/ 16.40 10/ 32.81	–	VW3A1104R10 VW3A1104R30 VW3A1104R50 VW3A1104R100	0.050/ 0.110 0.150/ 0.331 0.250/ 0.551 0.500/ 1.102
USB/Mini B USB cable for connecting the display terminal to a PC	–	–	TCSXCNAMUM3P	–
IP 65 remote mounting kit for Ethernet port (1) $\varnothing 22$ RJ45 female/ female adapter with seal	–	65	VW3A1115	0.200/ 0.441

Multidrop connection accessories

These accessories are used to connect a graphic display terminal to several drives via a multidrop link. This multidrop connection uses the RJ45 terminal port on the front of the drive.

Connection accessories

Description		Sold in lots of	Unit reference	Weight kg/ lb
Modbus splitter box 10 RJ45 connectors and 1 screw terminal block		–	LU9GC3	0.500/ 1.102
Modbus T-junction boxes	With 0.3 m/ 0.98 ft integrated cable	–	VW3A8306TF03	0.190/ 0.419
	With 1 m/ 3.28 ft integrated cable	–	VW3A8306TF10	0.210/ 0.463
Modbus line terminator	For RJ45 connector	R = 120 Ω C = 1 nf	2 VW3A8306RC	0.010/ 0.022

Cordsets (equipped with 2 RJ45 connectors)

Used for	Length m/ ft	Reference	Weight kg/ lb
Serial link	0.3/ 0.98	VW3A8306R03	0.025/ 0.055
	1/ 3.28	VW3A8306R10	0.060/ 0.132
	3/ 9.84	VW3A8306R30	0.130/ 0.287

(1) Used to connect a remote PC to the RJ45 port on an IP 21 drive mounted in an enclosure or on a wall. Drill hole with a standard $\varnothing 22$ tool, as used for a pushbutton. (Requires a remote-mounting cordset VW3A1104R●●● equipped with 2 RJ45 connectors).

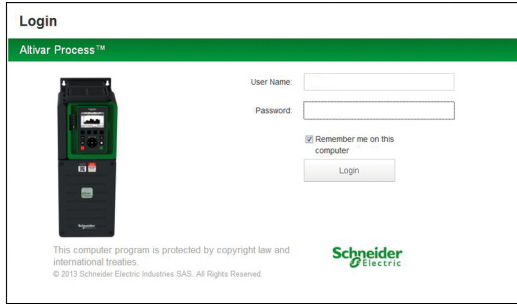

Login screen

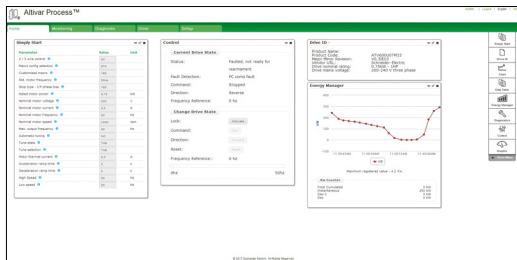

Customizable widgets

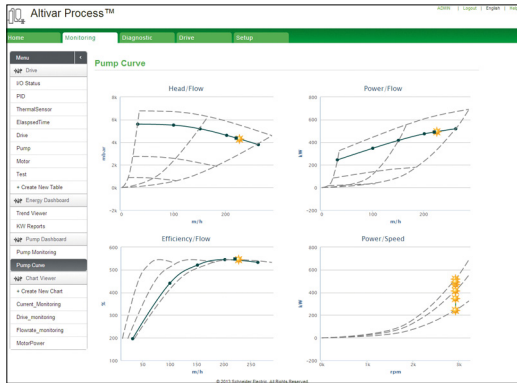

Pump curves

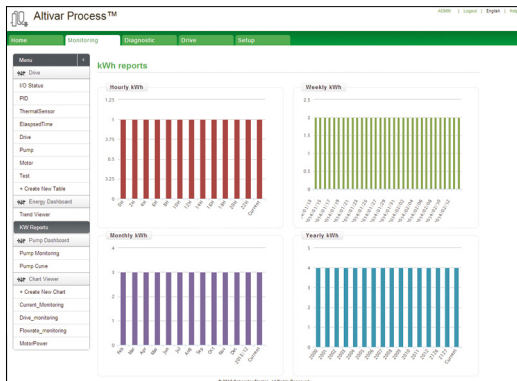

Energy dashboard

Web server

Presentation

- The Web server can be accessed:
 - For a drive not connected to an Ethernet network:
 - via an Ethernet cable or the Schneider Electric WiFi dongle (the drive then appears as a network device)
 - For a drive connected to an Ethernet network:
 - from any point on the network by entering the drive IP address
- The Web server is used for:
 - Commissioning the drive (setting configuration parameters and enabling the main functions)
 - Monitoring energy and process data, as well as drive and motor data
 - Diagnostics (drive status, file transfer, detected errors and warnings logs)

Description

The Web server is structured around 5 tabs.

- “My dashboard” tab:
 - Configurable using a wide choice of widgets; groups all the information selected by the user on one page
- “Display” tab:
 - Monitors energy indicators, efficiency, and performance
 - Displays process data such as optimum pump operation
 - Monitors drive parameters and status
 - Shows the I/O state and assignment
- “Diagnostics” tab:
 - Drive status
 - Time and date-stamped warning and detected errors logs
 - Network diagnostics
 - Access to drive self-tests
- “Drive” tab:
 - Access to the main drive adjustment parameters with contextual help
- “Setup” tab:
 - Network configuration
 - Access management
 - Transferring and retrieving drive configurations
 - Exporting data acquisition files and logs
 - Customizing pages (colors, logos, etc.)

Other characteristics:

- Ease of connection via the RJ45 port or WiFi connection
- Password-protected authentication (modifiable password; access rights can be configured by administrator)
- No downloads or installation necessary
- Web server can be disabled
- Works in a similar way on PCs, iPhones, iPads, Android systems, and the main web browsers:
 - Internet Explorer® (version 8 or higher)
 - Google Chrome® (version 11 or higher)
 - Mozilla Firefox® (version 4 or higher)
 - Safari® (version 5.1.7 or higher)

DTM

Presentation

Using FDT/DTM technology it is possible to configure, control, and diagnose Altivar Process drives directly in Unity Pro and SoMove software by means of the same software brick (DTM).

FDT/DTM technology standardizes the communication interface between field devices and host systems. The DTM contains a uniform structure for managing drive access parameters.

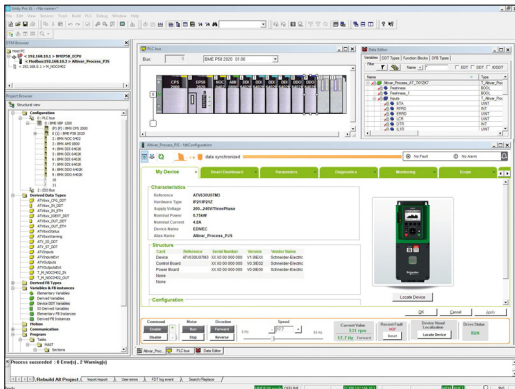

Altivar Process DTM in Unity

Specific functions of the Altivar Process DTM

- Offline or online access to drive data
- Drive firmware updates
- Transfer of configuration files from and to the drive
- Customization (dashboard, My Menu, etc.)
- Access to drive parameters and option cards
- Oscilloscope function
- Graphic interface to assist with configuration of the Altivar Process pump functions
- Energy and process dashboards
- Graphic display of system operation and comparison with optimum operation (pump curves)
- Detected errors and warnings logs (with timestamping)

Advantages of the DTM library in Unity Pro:

- Single tool for configuration, commissioning, and diagnostics
- Network scan for automatic recognition of network configuration
- Ability to add/remove, copy/paste configuration files from other drives in the same architecture
- Single input point for all parameters shared between the ePAC (programmable automation controller) and the Altivar Process drive
- Creation of drive profiles for implicit communication with the ePAC as well as dedicated profiles for programs with DFBs (derived function blocks)
- Integration in the fieldbus topology
- Drive configuration is an integral part of the Unity Pro project file (STU) and the archive file (STA)

Advantages of the DTM library in SoMove:

- Drive-oriented software environment
- Wired connection to the Ethernet communication port
- Standard cable (file transfer performance)

■ Third-party software and downloads:

The Altivar Process DTM library is a flexible, open, and interactive tool that can be used in a third-party FDT.

DTMs can be downloaded from our website www.schneider-electric.com.

SoMove software

Presentation

SoMove software for PC is used to configure, commission, and maintain Altivar Process drives.

In addition to the functions offered by the Web server, SoMove software features the oscilloscope function for accurate display of data samples.

For more information on SoMove software, visit our website www.schneider-electric.com.



SoMove software

Table showing possible combinations of options for ATV630...M3, ATV630...N4, ATV650...N4/N4E drives

Motor		Drive	Options		Passive filters (60 Hz)		EMC filters	IP 21 kit for EMC filter	Sinus filter	IP 21 kit for sinus filter	
kW	HP		Fan kit	Passive filters (50 Hz)	THDI < 10%	THDI < 5%					
Three-phase supply voltage: 200...240 V 50/60 Hz - IP 21											
11	15	ATV630D11M3	VX5VPS3001	–	–	–	–	VW3A4704	VW3A47904	VW3A5404	VW3A54904
15	20	ATV630D15M3	VX5VPS4001	–	–	–	–	VW3A4705	VW3A47905	VW3A5405	VW3A54905
18.5	25	ATV630D18M3	VX5VPS4001	–	–	–	–	VW3A4706	VW3A47906	VW3A5405	VW3A54905
22	30	ATV630D22M3	VX5VPS4001	–	–	–	–	VW3A4706	VW3A47906	VW3A5405	VW3A54905
30	40	ATV630D30M3	VX5VPS5001	–	–	–	–	VW3A4707	VW3A47907	VW3A5406	–
37	50	ATV630D37M3	VX5VPS5001	–	–	–	–	VW3A4707	VW3A47907	VW3A5406	–
45	60	ATV630D45M3	VX5VPS5001	–	–	–	–	VW3A4708	VW3A47908	VW3A5406	–
Three-phase supply voltage: 380...480 V 50/60 Hz - IP 21											
15	20	ATV630D15N4	VX5VPS3001	VW3A46105	VW3A46124	VW3A46143	VW3A46162	VW3A4703	VW3A47903	VW3A5404	VW3A54904
18.5	25	ATV630D18N4	VX5VPS3001	VW3A46106	VW3A46125	VW3A46144	VW3A46163	VW3A4704	VW3A47904	VW3A5404	VW3A54904
22	30	ATV630D22N4	VX5VPS3001	VW3A46107	VW3A46126	VW3A46145	VW3A46164	VW3A4704	VW3A47904	VW3A5404	VW3A54904
30	40	ATV630D30N4	VX5VPS4001	VW3A46108	VW3A46127	VW3A46146	VW3A46165	VW3A4705	VW3A47905	VW3A5405	VW3A54905
37	50	ATV630D37N4	VX5VPS4001	VW3A46109	VW3A46128	VW3A46147	VW3A46166	VW3A4706	VW3A47906	VW3A5405	VW3A54905
45	60	ATV630D45N4	VX5VPS4001	VW3A46110	VW3A46129	VW3A46148	VW3A46167	VW3A4706	VW3A47906	VW3A5405	VW3A54905
55	75	ATV630D55N4	VX5VPS5001	VW3A46111	VW3A46130	VW3A46149	VW3A46168	VW3A4707	VW3A47907	VW3A5406	–
75	100	ATV630D75N4	VX5VPS5001	VW3A46112	VW3A46131	VW3A46150	VW3A46169	VW3A4708	VW3A47908	VW3A5406	–
90	125	ATV630D90N4	VX5VPS5001	VW3A46113	VW3A46132	VW3A46151	VW3A46170	VW3A4708	VW3A47908	VW3A5406	–
Three-phase supply voltage: 380...480 V 50/60 Hz - IP 55											
15	20	ATV650D15N4	VX5VP50A001	VW3A46105 (1)	VW3A46124 (1)	VW3A46143 (1)	VW3A46162 (1)	–	–	VW3A5404 (1)	VW3A54904
18.5	25	ATV650D18N4	VX5VP50A001	VW3A46106 (1)	VW3A46125 (1)	VW3A46144 (1)	VW3A46163 (1)	–	–	VW3A5404 (1)	VW3A54904
22	30	ATV650D22N4	VX5VP50A001	VW3A46107 (1)	VW3A46126 (1)	VW3A46145 (1)	VW3A46164 (1)	–	–	VW3A5404 (1)	VW3A54904
30	40	ATV650D30N4	VX5VP50BC001	VW3A46108 (1)	VW3A46127 (1)	VW3A46146 (1)	VW3A46165 (1)	–	–	VW3A5405 (1)	VW3A54905
37	50	ATV650D37N4	VX5VP50BC001	VW3A46109 (1)	VW3A46128 (1)	VW3A46147 (1)	VW3A46166 (1)	–	–	VW3A5405 (1)	VW3A54905
45	60	ATV650D45N4	VX5VP50BC001	VW3A46110 (1)	VW3A46129 (1)	VW3A46148 (1)	VW3A46167 (1)	–	–	VW3A5405 (1)	VW3A54905
55	75	ATV650D55N4	VX5VP50BC001	VW3A46111 (1)	VW3A46130 (1)	VW3A46149 (1)	VW3A46168 (1)	–	–	VW3A5406 (1)	–
75	100	ATV650D75N4	VX5VP50BC001	VW3A46112 (1)	VW3A46131 (1)	VW3A46150 (1)	VW3A46169 (1)	–	–	VW3A5406 (1)	–
90	125	ATV650D90N4	VX5VP50BC001	VW3A46113 (1)	VW3A46132 (1)	VW3A46151 (1)	VW3A46170 (1)	–	–	VW3A5406 (1)	–
Three-phase supply voltage: 380...480 V 50/60 Hz - IP 55 with Vario disconnect switch											
15	20	ATV650D15N4E	VX5VP50A001	VW3A46105 (1)	VW3A46124 (1)	VW3A46143 (1)	VW3A46162 (1)	–	–	–	–
18.5	25	ATV650D18N4E	VX5VP50A001	VW3A46106 (1)	VW3A46125 (1)	VW3A46144 (1)	VW3A46163 (1)	–	–	–	–
22	30	ATV650D22N4E	VX5VP50A001	VW3A46107 (1)	VW3A46126 (1)	VW3A46145 (1)	VW3A46164 (1)	–	–	–	–
30	40	ATV650D30N4E	VX5VP50BC001	VW3A46108 (1)	VW3A46127 (1)	VW3A46146 (1)	VW3A46165 (1)	–	–	–	–
37	50	ATV650D37N4E	VX5VP50BC001	VW3A46109 (1)	VW3A46128 (1)	VW3A46147 (1)	VW3A46166 (1)	–	–	–	–
45	60	ATV650D45N4E	VX5VP50BC001	VW3A46110 (1)	VW3A46129 (1)	VW3A46148 (1)	VW3A46167 (1)	–	–	–	–
55	75	ATV650D55N4E	VX5VP50BC001	VW3A46111 (1)	VW3A46130 (1)	VW3A46149 (1)	VW3A46168 (1)	–	–	–	–
75	100	ATV650D75N4E	VX5VP50BC001	VW3A46112 (1)	VW3A46131 (1)	VW3A46150 (1)	VW3A46169 (1)	–	–	–	–
90	125	ATV650D90N4E	VX5VP50BC001	VW3A46113 (1)	VW3A46132 (1)	VW3A46151 (1)	VW3A46170 (1)	–	–	–	–
Pages		12	15	32	32	33	33	35	35	37	37

I/O expansion cards

Description	Reference	Page
Logic and analog I/O card	VW3A3203	23
Relay output card	VW3A3204	23

List of communication cards (2)

Description	Reference	Page
EtherNet/IP and Modbus TCP dual port	VW3A3720	27
CANopen daisy chain	VW3A3608	28
CANopen SUB-D	VW3A3618	28
CANopen screw terminal block	VW3A3628	29
ProfiNet	VW3A3627	30
PROFIBUS DP V1	VW3A3607	30
DeviceNet	VW3A3609	31

(1) When used with ATV650D15N4/N4E...D90N4/N4E drives, the filter must be mounted in a separate enclosure to maintain IP 55 protection for the installation.
 (2) For card compatibility table, see opposite.

Card compatibility table (1)

Type of card	Logic and analog I/O VW3A3203 (3)	Relay output VW3A3204 (3)	Communication VW3A3720 and VW3A36... (4)
Logic and analog I/O VW3A3203	Combination possible	Combination possible	Combination possible
Relay output VW3A3204	Combination possible	Combination possible	Combination possible
Communication VW3A3720 and VW3A36...	Combination possible	Combination possible	Combination possible

Combination possible
 Combination not possible

(3) Maximum combination involving two types of card is 2.
 (4) Maximum combination involving two types of card is 1.

PF140354

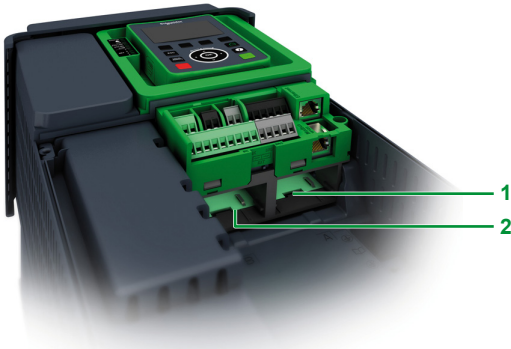

I/O expansion cards

Presentation

By installing I/O expansion cards Altivar Process drives can be adapted to meet the needs of applications that manage additional sensors or specific sensors.

2 expansion cards are available:

- Logic and analog I/O card
- Relay output card

These cards insert into slots A and B on Altivar Process drives:

- 1 Slot A for I/O expansion or communication cards
- 2 Slot B for I/O expansion cards only

Logic and analog I/O card

- 2 differential analog inputs configurable via software as current (0-20 mA/4-20 mA) or probe (PTC, PT100, or 2-wire or 3-wire PT1000) inputs
 - 14-bit resolution
- 6 x 24 V $\overline{\text{V}}$ positive or negative logic inputs
 - sampling: 1 ms max.
- 2 assignable logic outputs
- 2 removable spring terminal blocks

Relay output card

- 3 relay outputs with NO contacts
- 1 fixed screw terminal block

Note: Logic and analog I/O cards and relay output cards can go in either slot A or slot B on Altivar Process drives. However, the drives cannot take 2 cards of the same type (e.g., 2 logic and analog I/O cards or 2 relay output cards).

PF130896



VW3A3203

PF130897

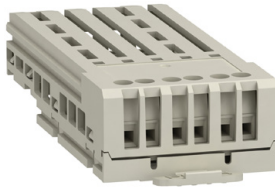

VW3A3204

I/O expansion cards						
Description	I/O type				Reference	Weight kg/ lb
	Logic inputs	Logic outputs	Analog inputs	Relay outputs		
Logic and analog I/O card	6	2	2 (1)	–	VW3A3203	–
Relay output card	–	–	–	3 (2)	VW3A3204	–

(1) Differential analog inputs configurable via software as current (0-20 mA/4-20 mA) or probe (PTC, PT100, or 2-wire or 3-wire PT1000) inputs. When configured as PTC probe inputs, they must never be used to protect an ATEX motor in applications in explosive atmospheres. Please refer to the ATEX guide on our website www.schneider-electric.com.

(2) NO contacts

Presentation

Altivar Process drives have 3 built-in RJ45 communication ports as standard:

- 1 Ethernet port
- 2 serial ports

Integrated communication protocols

Altivar Process drives integrate the Modbus TCP and Modbus serial link communication protocols as standard.

■ Ethernet port

This offers standard services regularly used in industrial networks:

- Modbus TCP message handling is based on the Modbus protocol and is used to exchange process data with other network devices (e.g., a PLC). It provides Altivar Process drives with access to the Modbus protocol and to the high performance of the Ethernet network, which is the communication standard for numerous devices.
- SNMP (Simple Network Management Protocol) offers standard diagnostics services for network management tools.
- The FDR (Fast Device Replacement) service allows automatic reconfiguration of a new device installed to replace an existing device.
- Possibility to reinforce device security by disabling some unused services as well as managing a list of authorized devices.
- Setup and adjustment tools (SoMove, Unity with DTM) can be connected locally or remotely.
- The embedded Web server is used to display operating data and dashboards as well as configure and diagnose process elements from any web browser.

These numerous services offered by the Ethernet port mean that Altivar Process drives can be integrated into Schneider Electric solutions.

■ Serial ports

- One port dedicated to field network operation for exchanging data with other devices via the Modbus protocol
- A second dedicated port for the multidrop connection of the following HMIs and configuration tools:
 - the remote graphic display terminal supplied with the drive
 - a Magelis industrial HMI terminal
 - a PC with SoMove or Unity setup software

The detailed specifications for the Ethernet or serial communication ports, and the Modbus and Modbus TCP protocols are available on our website www.schneider-electric.com.

Description

- 1 RJ45 Ethernet port
- 2 RJ45 serial port
- 3 Slot A for I/O expansion or communication cards
- 4 Slot B for I/O expansion cards
- 5 Removable screw terminal blocks for 24 V $\bar{\text{---}}$ power supply and integrated I/O
- 6 RJ45 serial link for HMI (remote graphic display terminal, Magelis terminal, etc.)

Altivar Process drives can only take one communication card, in slot A **3** only.

They cannot take 2 cards of the same type (e.g., 2 logic and analog I/O cards or 2 relay output cards).

The drives can take one logic and analog I/O card and one relay output card in either slot A **3** or slot B **4**.

Note: The user manuals and description files (*gsd*, *eds*, *xif*) for devices on the communication buses and networks are available on our website www.schneider-electric.com.

PF140354

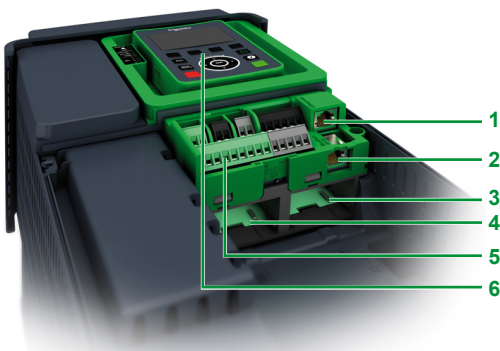

Optional communication cards

Altivar Process drives can also be connected to other industrial communication buses and networks using one of the communication cards available as an option. Communication cards are supplied in “cassette” format for ease of mounting/removal.

Dedicated communication cards:

- EtherNet/IP and Modbus TCP dual port
- CANopen:
 - RJ45 daisy chain
 - SUB-D
 - Screw terminals
- ProfiNet
- PROFIBUS DP V1
- DeviceNet

ProfiNet and PROFIBUS DP V1 cards also support the Profidrive and CiA402 profiles.

It is possible to maintain communication using a separate power supply for the control and power sections. Monitoring and diagnostics are possible via the network even if there is no power supply to the power section.

Functions

All drive functions can be accessed via the various communication networks:

- Configuration
- Adjustment
- Control
- Monitoring

Altivar Process drives offer a high degree of interfacing flexibility with the possibility to assign, by configuration, the different control sources (I/O, communication networks, and HMI terminal) to control functions in order to meet the requirements of complex applications.

Network services and parameters are configured using the SoMove drive setup software, or in Unity software if the drive is being integrated into a PlantStruXure architecture.

Communication is monitored according to the specific criteria for each protocol. However, regardless of the protocol, it is possible to configure how the drive responds to a detected communication interruption, as follows:

- Define the type of stop when a communication interruption is detected
- Maintain last command received
- Fallback position at preset speed
- Ignore the detected communication interruption

Variable speed drives

Altivar Process

Communication buses and networks

Integrated ports

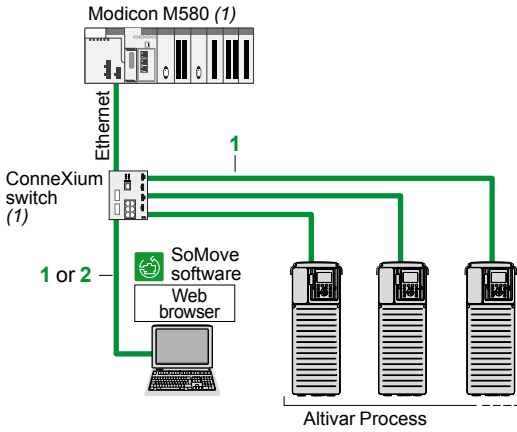

Example of Ethernet architecture

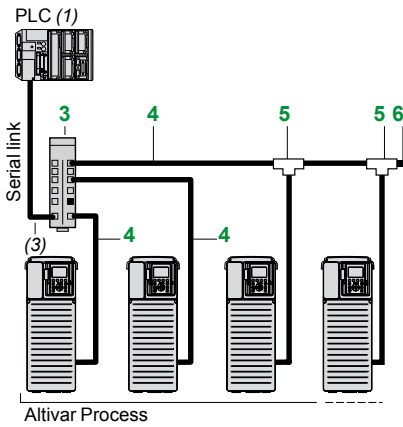

Example of serial link architecture

Integrated Ethernet port

Description	Item	Length m/ ft	Unit reference	Weight kg/ lb
ConneXium cordsets (2)				
Straight shielded twisted pair cables equipped with 2 RJ45 connectors conforming to EIA/TIA-568 category 5 and IEC 11801/EN 50173-1 class D	1	2/ 6.56	490NTW00002	–
		5/ 16.40	490NTW00005	–
		12/ 39.37	490NTW00012	–
Crossover shielded twisted pair cables equipped with 2 RJ45 connectors conforming to EIA/TIA-568 category 5 and IEC 11801/EN 50173-1 class D	2	5/ 16.40	490NTC00005	–
		15/ 49.21	490NTC00015	–
Straight shielded twisted pair cables equipped with 2 RJ45 connectors conforming to UL and CSA 22.1	1	2/ 6.56	490NTW00002U	–
		5/ 16.40	490NTW00005U	–
		12/ 39.37	490NTW00012U	–
Crossover shielded twisted pair cables equipped with 2 RJ45 connectors conforming to UL and CSA 22.1	2	5/ 16.40	490NTC00005U	–
		15/ 49.21	490NTC00015U	–

Integrated serial port

Description	Item	Length m/ ft	Unit reference	Weight kg/ lb	
Connection accessories					
Splitter box 10 RJ45 connectors and 1 screw terminal block	3	–	LU9GC3	0.500/ 1.102	
Modbus T-junction boxes	With 0.3 m/0.98 ft integrated cable	5	0.3/ 0.98	VW3A8306TF03	0.190/ 0.419
		5	1/ 3.28	VW3A8306TF10	0.210/ 0.463
Modbus line terminator (4)	For RJ45 connector R = 120 Ω C = 1 nf	6	–	VW3A8306RC	0.010/ 0.022
Cordsets equipped with 2 RJ45 connectors		4	0.3/ 0.98	VW3A8306R03	0.025/ 0.055
			1/ 3.28	VW3A8306R10	0.060/ 0.132
			3/ 9.84	VW3A8306R30	0.130/ 0.287

(1) Please refer to the "Modicon automation platform" catalogs on our website www.schneider-electric.com.

(2) Also exist in 40 and 80 m/131 and 262 ft lengths. For other ConneXium connection accessories, please consult our website www.schneider-electric.com.

(3) Cable depends on the PLC.

(4) Order in multiples of 2.

Variable speed drives

Altivar Process

Communication buses and networks

Option: Communication cards

PF130914A



VW3A3720

Modicon M580 (2)

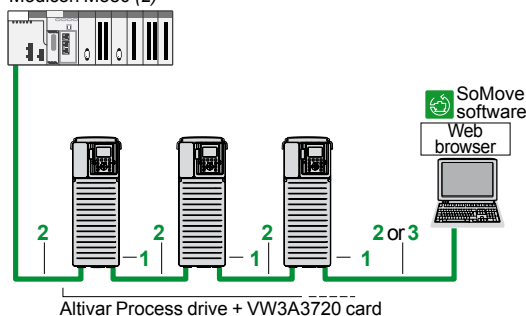

Example of connection on an EtherNet/IP network

EtherNet/IP and Modbus TCP networks (1)

Description	Item	Length m/ ft	Unit reference	Weight kg/ lb
Communication card				
EtherNet/IP and Modbus TCP dual port card For connection to the Modbus TCP network or EtherNet/IP network Ports: 2 RJ45 connectors ■ 10/100 Mbps, half duplex and full duplex ■ Embedded Web server Requires cordset 490NTW000●●/●●U or 490NTC000●●/●●U	1	–	VW3A3720	0.020/ 0.044

ConneXium cordsets (3)

Straight shielded twisted pair cables equipped with 2 RJ45 connectors conforming to EIA/TIA-568 category 5 and IEC 11801/EN 50173-1 class D	2	2/ 6.56	490NTW00002	–
		5/ 16.40	490NTW00005	–
		12/ 39.37	490NTW00012	–
Crossover shielded twisted pair cables equipped with 2 RJ45 connectors conforming to EIA/TIA-568 category 5 and IEC 11801/EN 50173-1 class D	3	5/ 16.40	490NTC00005	–
		15/ 49.21	490NTC00015	–
Straight shielded twisted pair cables equipped with 2 RJ45 connectors conforming to UL and CSA 22.1	2	2/ 6.56	490NTW00002U	–
		5/ 16.40	490NTW00005U	–
		12/ 39.37	490NTW00012U	–
Crossover shielded twisted pair cables equipped with 2 RJ45 connectors conforming to UL and CSA 22.1	3	5/ 16.40	490NTC00005U	–
		15/ 49.21	490NTC00015U	–

(1) Altivar Process drives can only take one communication card.

(2) Please refer to the "M580 automation platform" catalog on our website www.schneider-electric.com.

(3) Also exist in 40 and 80 m/131 and 262 ft lengths. For other ConneXium connection accessories, please consult our website www.schneider-electric.com.

Variable speed drives

Altivar Process

Communication buses and networks

Option: Communication cards



VW3A3608

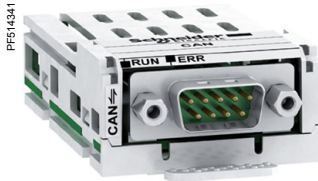

VW3A3618

PLC (2)

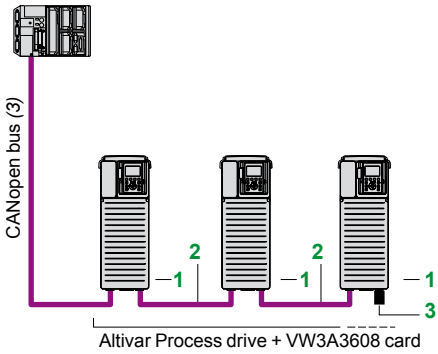

Optimized solution for daisy chain connection to the CANopen bus

PLC (2)

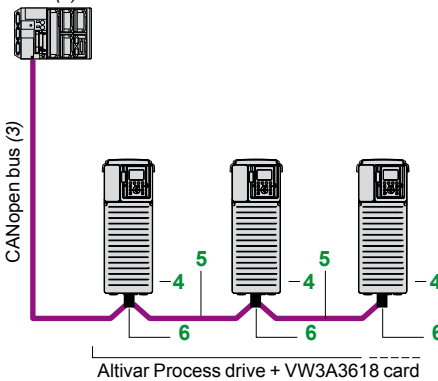

Example of connection to the CANopen bus via SUB-D connector

CANopen bus (1)

Description	Item	Length m/ ft	Unit reference	Weight kg/ lb
-------------	------	--------------------	----------------	---------------------

Communication card

CANopen daisy chain card Ports: 2 RJ45 connectors	1	-	VW3A3608	-
---	---	---	----------	---

Connection to RJ45 connector (optimized solution for daisy chain connection on CANopen bus)

CANopen cordsets equipped with 2 RJ45 connectors	2	0.3/ 0.98	VW3CANCARR03	0.050/ 0.110
		1/ 3.28	VW3CANCARR1	0.500/ 1.102

CANopen line terminator for RJ45 connector	3	-	TCSCAR013M120	-
---	---	---	---------------	---

Communication card

CANopen SUB-D card Ports: 1 x 9-way male SUB-D connector	4	-	VW3A3618	-
--	---	---	----------	---

Connection to SUB-D connector

CANopen cables (3) (4) Standard cable, C€ mark Low smoke zero halogen Flame-retardant (IEC 60332-1)	5	50/ 164.04	TSXCANCA50	4.930/ 10.869
		100/ 328.08	TSXCANCA100	8.800/ 19.401
		300/ 984.25	TSXCANCA300	24.560/ 54.145

CANopen cables (3) (4) UL certification, C€ mark Flame-retardant (IEC 60332-2)	5	50/ 164.04	TSXCANCB50	3.580/ 7.893
		100/ 328.08	TSXCANCB100	7.840/ 17.284
		300/ 984.25	TSXCANCB300	21.870/ 48.215

CANopen cables (3) (4) Cable for harsh environments or mobile installations, C€ mark Low smoke zero halogen Flame retardant (IEC 60332-1)	5	50/ 164.04	TSXCANCD50	3.510/ 7.738
		100/ 328.08	TSXCANCD100	7.770/ 17.130
		300/ 984.25	TSXCANCD300	7.770/ 17.130

IP 20 straight CANopen connector (5) 9-way female SUB-D connector with line terminator that can be deactivated For connecting CAN-H, CAN-L, and CAN-GND	6	-	TSXCANKCDF180T	0.049/ 0.108
--	---	---	----------------	-----------------

- (1) Altivar Process drives can only take one communication card.
- (2) Please refer to the "Modicon automation platform" catalogs on our website www.schneider-electric.com.
- (3) Cable depends on the PLC.
- (4) Standard environment:
 - no particular environmental constraints
 - operating temperature between +5 and +60 °C/+41 and +140 °F
 - fixed installation
 Harsh environment:
 - resistance to hydrocarbons, industrial oils, detergents, solder splashes
 - relative humidity up to 100%
 - saline atmosphere
 - operating temperature between -10 and +70 °C/+14 and +158 °F
 - significant temperature variations
- (5) Only straight connectors are compatible with Altivar Process drives.

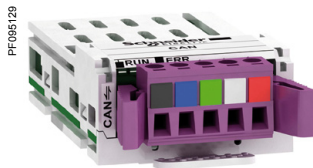

VW3A3628

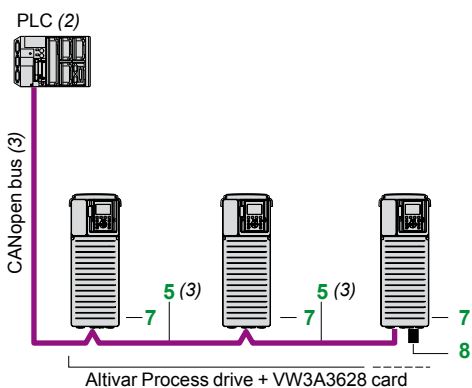

Example of connection to the CANopen bus via screw terminals

CANopen bus (continued) (1)

Description	Item	Length m/ ft	Unit reference	Weight kg/ lb
Communication card				
CANopen card Port: 1 x 5-way screw terminal block	7	–	VW3A3628	–
Connection to screw terminals				
IP 20 CANopen cordsets (3) equipped with 2 x 9-way female SUB-D connectors	5	0.3/ 0.98	TSXCANCADD03	0.091/ 0.201
Standard cable, C€ mark		1/	TSXCANCADD1	0.143/ 0.315
Low smoke zero halogen		3.28		
Flame-retardant (IEC 60332-1)		3/ 9.84	TSXCANCBDD3	0.268/ 0.591
		5/ 16.40	TSXCANCBDD5	0.400/ 0.882
IP20 CANopen junction boxes equipped with: ■ 4 x 9-way male SUB-D connectors + screw terminal block for trunk cable tap link ■ line terminator	–	–	TSXCANTDM4	0.196/ 0.432
IP20 CANopen junction boxes equipped with: ■ 2 screw terminal blocks for trunk cable tap link ■ 2 RJ45 connectors for connecting drives ■ 1 RJ45 connector for connecting a PC	–	–	VW3CANTAP2	–
CANopen line terminator for screw terminal connector (4)	8	–	TCSCAR01NM120	–

(1) Altivar Process drives can only take one communication card.

(2) Please refer to the "Modicon automation platform" catalogs on our website www.schneider-electric.com.

(3) Cable depends on the PLC.

(4) Order in multiples of 2.

Variable speed drives

Altivar Process

Communication buses and networks

Option: Communication cards

PF514350

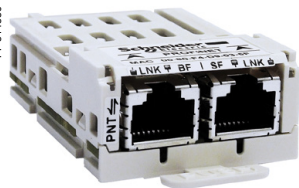

VW3A3627

ProfiNet bus (1)

Description	Reference	Weight kg/ lb
Communication card		
ProfiNet card equipped with 2 RJ45 connectors	VW3A3627	0.290/ 0.639

PF095130

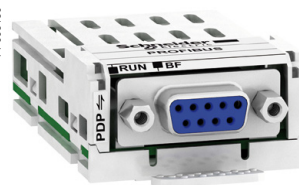

VW3A3607

PROFIBUS DP V1 bus (1)

Description	Reference	Weight kg/ lb
Communication card		
PROFIBUS DP V1 card Port: 1 x 9-way female SUB-D connector Conforming to PROFIBUS DP V1 Profiles supported: ■ CiA 402 drive ■ Profidrive Offers several message handling modes based on DP V1	VW3A3607	0.140/ 0.309

SUB-D connection

IP 20 straight connectors (2) for Profibus card	LU9AD7	–
--	---------------	---

(1) Altivar Process drives can only take one communication card.

(2) Only straight connectors are compatible with Altivar Process drives.

Variable speed drives

Altivar Process

Communication buses and networks

Option: Communication cards

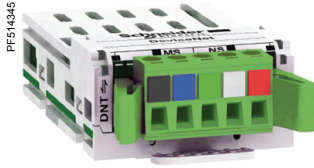

VW3A3609

DeviceNet bus (1)

Description	Reference	Weight kg/ lb
Communication card		
DeviceNet card	VW3A3609	0.300/ 0.661
Port: 1 removable 5-way screw connector		
Profiles supported:		
■ CIP AC DRIVE		
■ CiA 402 drive		

(1) Altivar Process drives can only take one communication card.

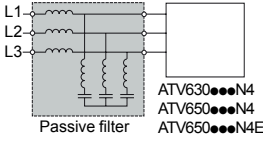

Presentation

Passive filters are used to obtain total harmonic distortion of less than 10% or 5%. Reactive power increases at no load or low load. To help reduce this reactive power, the filter capacitors can be disconnected (see the diagrams on our website www.schneider-electric.com). Passive filters provide IP 20 protection.

Applications

Reduction of current harmonics in order to use drives in the first environment (restricted distribution, domestic applications, sale conditional on the competence of the user and the distributor in terms of reducing current harmonics).



VW3A46106

Passive filters: 400 V 50 Hz three-phase supply

Motor rating	For Altivar Process drives	Filter		Quantity required per drive	Reference (1)	Weight
		Nominal current Input	Nominal current Output			
kW	HP	A	A			kg/lb
THDI < 10% (2)						
15	20	ATV630D15N4 ATV650D15N4 ATV650D15N4E	29	30	1	VW3A46105 25.000/ 55.116
18.5	25	ATV630D18N4 ATV650D18N4 ATV650D18N4E	35	37	1	VW3A46106 37.000/ 81.571
22	30	ATV630D22N4 ATV650D22N4 ATV650D22N4E	43	45	1	VW3A46107 39.000/ 85.980
30	40	ATV630D30N4 ATV650D30N4 ATV650D30N4E	58	60	1	VW3A46108 44.000/ 97.003
37	50	ATV630D37N4 ATV650D37N4 ATV650D37N4E	72	75	1	VW3A46109 56.000/ 123.459
45	60	ATV630D45N4 ATV650D45N4 ATV650D45N4E	86	90	1	VW3A46110 62.000/ 136.686
55	75	ATV630D55N4 ATV650D55N4 ATV650D55N4E	101	105	1	VW3A46111 74.000/ 163.142
75	100	ATV630D75N4 ATV650D75N4 ATV650D75N4E	144	150	1	VW3A46112 85.000/ 187.393
90	125	ATV630D90N4 ATV650D90N4 ATV650D90N4E	180	187	1	VW3A46113 102.000/ 224.871
THDI < 5% (2)						
15	20	ATV630D15N4 ATV650D15N4 ATV650D15N4E	29	30	1	VW3A46124 34.000/ 74.957
18.5	25	ATV630D18N4 ATV650D18N4 ATV650D18N4E	35	37	1	VW3A46125 53.000/ 116.845
22	30	ATV630D22N4 ATV650D22N4 ATV650D22N4E	43	45	1	VW3A46126 58.000/ 127.868
30	40	ATV630D30N4 ATV650D30N4 ATV650D30N4E	58	60	1	VW3A46127 76.000/ 167.551
37	50	ATV630D37N4 ATV650D37N4 ATV650D37N4E	72	75	1	VW3A46128 98.000/ 216.053
45	60	ATV630D45N4 ATV650D45N4 ATV650D45N4E	86	90	1	VW3A46129 104.000/ 229.281
55	75	ATV630D55N4 ATV650D55N4 ATV650D55N4E	101	105	1	VW3A46130 106.000/ 233.690
75	100	ATV630D75N4 ATV650D75N4 ATV650D75N4E	144	150	1	VW3A46131 126.000/ 277.782
90	125	ATV630D90N4 ATV650D90N4 ATV650D90N4E	180	187	1	VW3A46132 135.000/ 297.623

(1) When used with ATV650D15/N4E...D90/N4E drives, the filter must be mounted in a separate enclosure to maintain IP 55 protection for the installation.

(2) Integrated DC choke.

Passive filters: 480 V 60 Hz three-phase supply							
Motor rating		For Altivar Process drives	Filter		Quantity required per drive	Reference (1)	Weight
kW	HP		Nominal current				
			Input	Output			
		A	A			kg/lb	
THDI < 10% (2)							
15	20	ATV630D15N4 ATV650D15N4 ATV650D15N4E	25	26	1	VW3A46143	23.000/ 50.706
18.5	25	ATV630D18N4 ATV650D18N4 ATV650D18N4E	31	32	1	VW3A46144	33.000/ 72.752
22	30	ATV630D22N4 ATV650D22N4 ATV650D22N4E	36	37	1	VW3A46145	37.000/ 81.571
30	40	ATV630D30N4 ATV650D30N4 ATV650D30N4E	48	50	1	VW3A46146	39.000/ 85.980
37	50	ATV630D37N4 ATV650D37N4 ATV650D37N4E	60	62	1	VW3A46147	43.000/ 94.799
45	60	ATV630D45N4 ATV650D45N4 ATV650D45N4E	73	76	1	VW3A46148	55.000/ 121.254
55	75	ATV630D55N4 ATV650D55N4 ATV650D55N4E	95	99	1	VW3A46149	62.000/ 136.686
75	100	ATV630D75N4 ATV650D75N4 ATV650D75N4E	118	122	1	VW3A46150	74.000/ 163.142
90	125	ATV630D90N4 ATV650D90N4 ATV650D90N4E	154	160	1	VW3A46151	85.000/ 187.393
THDI < 5% (2)							
15	20	ATV630D15N4 ATV650D15N4 ATV650D15N4E	25	26	1	VW3A46162	34.000/ 74.957
18.5	25	ATV630D18N4 ATV650D18N4 ATV650D18N4E	31	32	1	VW3A46163	52.000/ 114.640
22	30	ATV630D22N4 ATV650D22N4 ATV650D22N4E	36	37	1	VW3A46164	53.000/ 116.845
30	40	ATV630D30N4 ATV650D30N4 ATV650D30N4E	48	50	1	VW3A46165	57.000/ 125.663
37	50	ATV630D37N4 ATV650D37N4 ATV650D37N4E	60	62	1	VW3A46166	75.000/ 165.347
45	60	ATV630D45N4 ATV650D45N4 ATV650D45N4E	73	76	1	VW3A46167	97.000/ 213.848
55	75	ATV630D55N4 ATV650D55N4 ATV650D55N4E	95	99	1	VW3A46168	104.000/ 229.281
75	100	ATV630D75N4 ATV650D75N4 ATV650D75N4E	118	122	1	VW3A46169	106.000/ 233.690
90	125	ATV630D90N4 ATV650D90N4 ATV650D90N4E	154	160	1	VW3A46170	126.000/ 277.782

(1) When used with **ATV650D15/N4E...D90/N4E** drives, the filter must be mounted in a separate enclosure to maintain IP 55 protection for the installation.

(2) Integrated DC choke.

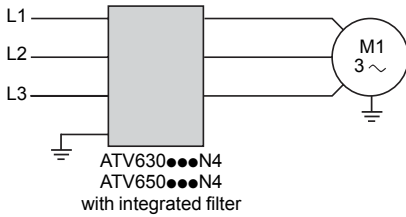

Altivar Process drive with integrated EMC filter

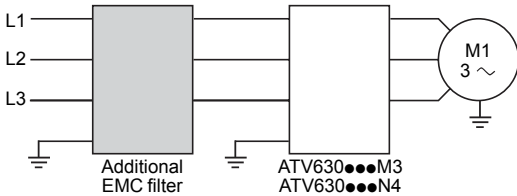

Altivar Process drive with additional EMC filter

Integrated EMC filters

Altivar Process drives (except ATV630D11M3...D45M3) have integrated radio interference input filters in accordance with the EMC standard for variable speed electrical power drive “products” IEC/EN 61800-3, edition 2, category C2 or C3 in environment 1 or 2, and to comply with the European EMC (electromagnetic compatibility) directive.

For drives

Maximum length of shielded cable ⁽¹⁾ acc. to
 IEC/EN 61800-3 category C2 IEC/EN 61800-3 category C3
 m m

Three-phase supply voltage: 380...480 V IP 21

ATV630D15N4... D22N4	50	150
ATV630D30N4... D45N4	50	150
ATV630D55N4... D90N4	–	150

Three-phase supply voltage: 380...480 V IP 55

ATV650D15N4...D22N4	50	150
ATV650D30N4...D45N4	50	150
ATV650D55N4...D90N4	–	150

Additional EMC input filters

Additional EMC input filters can be used to meet more stringent requirements and are designed to reduce conducted emissions on the line supply below the limits of standard IEC/EN 61800-3 category C1 or C2.

Use according to the type of line supply

Use of these additional filters is only possible on TN (neutral connection) and TT (grounded neutral) type systems.

Standard IEC/EN 61800-3, appendix D2.1, states that on IT systems (isolated or impedance grounded neutral), filters can cause permanent insulation monitors to operate in a random manner.

If a machine needs to be installed on an IT system, one solution is to insert an isolation transformer and connect the machine locally to a TN or TT system.

⁽¹⁾ Values given depend on the nominal switching frequency of the drive. This frequency depends on the drive rating. If motors are connected in parallel, it is the total length of all cables that should be taken into account.

Variable speed drives

Altivar Process: EMC filters

Option: Additional EMC input filters

Additional EMC input filters						
For drives	Maximum length of shielded cable (1)		In (2)	If	Reference	Weight
	IEC/EN 61800-3 category C2 (3)	IEC/EN 61800-3 category C3 (3)				
	m	m	A	mA		kg/ lb
Three-phase supply voltage: 200...240 V 50 Hz						
ATV630D11M3	150	300	50	7.6	VW3A4704	5.200/ 11.464
ATV630D15M3	150	300	70	3.98	VW3A4705	6.100/ 13.448
ATV630D18M3...D22M3	150	300	100	3.98	VW3A4706	6.500/ 14.330
ATV630D30M3...D37M3	150	300	160	13.9	VW3A4707	8.500/ 18.739
ATV630D45M3	150	300	200	13.9	VW3A4708	9.500/ 20.944
Three-phase supply voltage: 380...480 V 50 Hz						
ATV630D15N4	150	300	35	7.6	VW3A4703	4.100/ 9.039
ATV630D18N4...D22N4	150	300	50	7.6	VW3A4704	5.200/ 11.464
ATV630D30N4	150	300	70	3.98	VW3A4705	6.100/ 13.448
ATV630D37N4...D45N4	150	300	100	3.98	VW3A4706	6.500/ 14.330
ATV630D55N4	150	300	160	13.9	VW3A4707	8.500/ 18.739
ATV630D75N4...D90N4	150	300	200	13.9	VW3A4708	9.500/ 20.944

IP 21 protection kit

Additional input filters provide IP 20 protection as standard. This kit can be used to provide IP 21 or UL type 1 protection.

Description	For filters	Reference	Weight kg/ lb
Mechanical kit including cover and cable clamps	VW3A4703	VW3A47903	0.400/ 0.882
	VW3A4704	VW3A47904	0.500/ 1.102
	VW3A4705	VW3A47905	0.900/ 1.984
	VW3A4706	VW3A47906	1.000/ 2.205
	VW3A4707	VW3A47907	1.500/ 3.307
	VW3A4708	VW3A47908	2.000/ 4.409

(1) The maximum lengths are given as examples only as they vary depending on the stray capacitance of the motors and the cables used. If motors are connected in parallel, it is the total length of all cables that should be taken into account.

(2) Nominal filter current.

(3) Values given depend on the nominal switching frequency of the drive. This frequency depends on the drive rating.

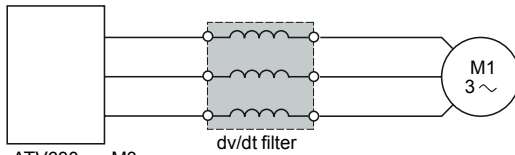

ATV630●●●M3
ATV630●●●N4
ATV650●●●N4

Altivar Process drive with dv/dt filter

Presentation

Altivar Process drives operate with the following maximum motor cable lengths: 150 m/492 ft for shielded cables and 300 m/984 ft for unshielded cables. To limit the impact of dv/dt filters and overvoltages at the motor side, it is recommended, for cables longer than 50 m/164 ft, that you check the motor insulation type and add an output filter if necessary.

Output filters are used to limit dv/dt at the motor terminals.

They are also used to:

- Limit overvoltages at the motor terminals to:
 - 1000 V at 400 V ~ (rms value)
- Filter interference caused by opening a contactor placed between the filter and the motor
- Reduce the motor ground leakage current

The performance of dv/dt filters will be affected if the maximum cable lengths are exceeded. For an application with several motors connected in parallel, the cable length must include all cabling. If a cable longer than that recommended is used, the dv/dt filters may overheat.

dv/dt output filters						
For drives	Maximum length of motor cable		Degree of protection	Nominal current	Unit reference	Weight
	Maximum switching frequency (1)	Shielded cable (2)				
	kHz	m/ft	IP	A		kg/lb
Three-phase supply voltage: 200...240 V						
ATV630D11M3	4	500/1640	20	50	VW3A5304	18.000/ 39.683
ATV630D15M3...D22M3	4	500/1640	20	95	VW3A5305	19.000/ 41.888
ATV630D30M3...D45M3	2.5	500/1640	00	180	VW3A5306	22.000/ 48.502
Three-phase supply voltage: 380...480 V						
ATV630D15N4...D22N4	4	500/1640	20	50	VW3A5304	18.000/ 39.683
ATV650D15N4...D22N4 (3)						
ATV630D30N4...D45N4	4	500/1640	20	95	VW3A5305	19.000/ 41.888
ATV650D30N4...D45N4 (3)						
ATV630D55N4...D90N4	2.5	500/1640	00	180	VW3A5306	22.000/ 48.502
ATV650D55N4...D90N4 (3)						

IP 21 protection kits

Description	For dv/dt filters	Reference	Weight kg/lb
Mechanical kit including cover and cable clamps	VW3A5304	VW3A53904	1.500/ 3.307
	VW3A5305	VW3A53905	1.500/ 3.307

(1) The filters are designed to operate in a switching frequency range of between 2 and 8 kHz.

(2) Values given depend on the nominal switching frequency of the drive. This frequency depends on the drive rating. These cable lengths are given as examples only as they can vary depending on the application. They correspond to motors conforming to IEC 6034-25 and NEMA MG1/31.2006.

(3) When used with **ATV650D15N4...D90N4** drives, the filter must be mounted in a separate enclosure to maintain IP 55 protection for the installation.

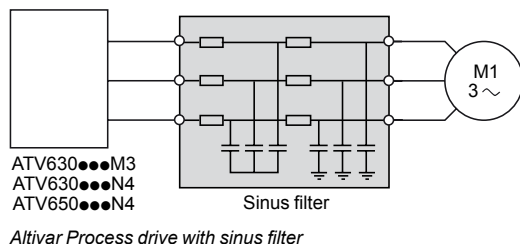

Presentation

Sinus filters allow Altivar Process drives to operate with long motor cables. The sinus filter only works when the option has been enabled in the drive settings (refer to the Programming Manual on our website www.schneider-electric.com).

Applications

For applications requiring:

- long cable runs
- motors connected in parallel
- submersible pumps sensitive to dv/dt
- an intermediate transformer between the drive and the motor

Sinus filters

For drives	Nominal current A	Degree of protection IP	Reference (1)	Weight kg/ lb
Three-phase supply voltage: 200...240 V				
ATV630D11M3	50	20	VW3A5404	35.000/ 77.162
ATV630D15M3...D22M3	95	20	VW3A5405	60.000/ 132.277
ATV630D30M3...D45M3	180	00	VW3A5406	90.000/ 198.416

Three-phase supply voltage: 380...480 V

ATV630D15N4...D22N4 ATV650D15N4...D22N4 (2)	50	20	VW3A5404	35.000/ 77.162
ATV630D30N4...D45N4 ATV650D30N4...D45N4 (2)	95	20	VW3A5405	60.000/ 132.277
ATV630D55N4...D90N4 ATV650D55N4...D90N4 (2)	180	00	VW3A5406	90.000/ 198.416

IP 21 protection kits

Description	For sinus filter	Reference	Weight kg/ lb
Mechanical kit including cover and cable clamps	VW3A5404	VW3A54904	1.500/ 3.307
	VW3A5405	VW3A54905	1.800/ 3.968

(1) The filters are designed to operate in a switching frequency range of between 2 and 8 kHz.

(2) When used with **ATV650D15N4...D90N4** drives, the filter must be mounted in a separate enclosure to maintain IP 55 protection for the installation.

Applications

Circuit breaker/contactor/drive combinations help to ensure continuity of service in an installation. The type of circuit breaker/contactor coordination selected can help reduce maintenance costs in the event of a motor short-circuit on the drive input by minimizing the time required to make the necessary repairs and the cost of replacement equipment. The suggested combinations provide coordination according to the drive rating.

The drive controls the motor, provides a monitoring function against short-circuits between the drive and the motor, and helps protect the motor cable against overloads. Overload monitoring is provided by the drive's motor thermal monitoring function if this has been enabled. Otherwise, an external monitoring device such as a probe or thermal overload relay should be provided.

The circuit breaker helps protect the drive's power cables against short-circuits.

IEC standard motor starters

Motor	Drive	Circuit breaker			Line contactor	
Power (1)	Reference	Reference (2)	Rating	I _{rm}	Reference (3) (4)	
kW	HP		A	A		
Three-phase supply voltage: 200...240 V 50/60 Hz						
11	15	ATV630D11M3	GV3L40	40	560	LC1D40A●●
15	20	ATV630D15M3	GV3L65	65	910	LC1D65A●●
18.5	25	ATV630D18M3	NS80HMA	80	1,000	LC1D65A●●
22	30	ATV630D22M3	NS80HMA	80	1,000	LC1D80●●
30	40	ATV630D30M3	NSX100●MA100	100	1,300	LC1D95●●
37	50	ATV630D37M3	NSX160●MA150	150	1,500	LC1D115●●
45	60	ATV630D45M3	NSX160●MA150	150	1,500	LC1D150●●

(1) Standard power ratings for 230 V 50/60 Hz 4-pole motors.

The values expressed in HP conform to the NEC (National Electrical Code).

(2) For references to be completed, replace the dot with the letter corresponding to the breaking performance of the circuit breaker (F, N, H, S or L).

Breaking capacity of circuit breakers according to standard IEC 60947-2:

Circuit breaker	I _{cu} (kA) for 200...240 V					
	F	N	H	S	L	
GV3L40...65	50	–	–	–	–	
NS80HMA	100	–	–	–	–	
NSX100●MA100	–	85	90	100	120	
NSX160●MA150	–	85	90	100	120	

(3) Composition of contactors:

LC1D40...D150: 3 poles + 1 NO auxiliary contact and 1 NC auxiliary contact.

To add auxiliary contacts or other accessories, please refer to the "Motor-starter solutions - Control and protection components" catalog.

(4) Replace ●● with the control circuit voltage reference indicated in the table below:

LC1D40...D150	Volts ~	24	48	110	220	230	240
		50 Hz	B5	E5	F5	M5	P5
60 Hz	B6	E6	F6	M6	–	U6	
50/60 Hz	B7	E7	F7	M7	P7	U7	

For other voltages available between 24 V and 660 V, or a DC control circuit, please contact our Customer Care Centre.



GV3L40

+



LC1D40A●●

+



ATV630D11M3



NSX100FMA100

+



LC1D80●●

+



ATV630D45N4

IEC standard motor starters						
Motor	Drive	Circuit breaker			Line contactor	
Power (1)	Reference	Reference (2)	Rating	I _{rm}	Reference (3) (4)	
kW	HP		A	A		
Three-phase supply voltage: 380...415 V 50/60 Hz						
15	20	ATV630D15N4	GV3L32	32	448	LC1D25●●
18.5	25	ATV630D18N4	GV3L40	40	560	LC1D40A●●
22	30	ATV630D22N4	GV3L50	50	700	LC1D50A●●
30	40	ATV630D30N4	GV3L65	65	910	LC1D50A●●
37	50	ATV630D37N4	NS80HMA	80	1,000	LC1D65A●●
45	60	ATV630D45N4	NSX100●MA100	100	1,300	LC1D80●●
55	75	ATV630D55N4	NSX160●MA150	150	1,500	LC1D115●●
75	100	ATV630D75N4	NSX160●MA150	150	1,500	LC1D115●●
90	125	ATV630D90N4	NSX250●MA220	220	2,420	LC1F185●●
Three-phase supply voltage: 440 V 50/60 Hz						
15	20	ATV630D15N4	GV3L32	32	448	LC1D25●●
18.5	25	ATV630D18N4	GV3L40	40	560	LC1D40A●●
22	30	ATV630D22N4	GV3L50	50	700	LC1D50A●●
30	40	ATV630D30N4	GV3L65	65	910	LC1D50A●●
37	50	ATV630D37N4	GV3L66	65	910	LC1D65A●●
45	60	ATV630D45N4	NS80HMA	80	1,000	LC1D80●●
55	75	ATV630D55N4	NSX100●MA100	100	1,040	LC1D95●●
75	100	ATV630D75N4	NSX160●MA150	150	1,500	LC1D115●●
90	125	ATV630D90N4	NSX250●MA220	150	1,500	LC1D115●●

(1) Standard power ratings for 4-pole motors 400 V 50/60 Hz.

The values expressed in HP comply with the NEC (National Electrical Code).

(2) For references to be completed, replace the dot with the letter corresponding to the breaking performance of the circuit breaker (F, N, H, S or L).

Breaking capacity of circuit breakers according to standard IEC 60947-2:

Circuit breaker	Icu (kA) for 380...415 V					
	F	N	H	S	F	L
GV3L32...65	50	–	–	–	–	–
NS80HMA	70	–	–	–	–	–
NSX100●MA100	–	36	50	70	100	150
NSX160●MA150	–	36	50	70	100	150
NSX250●MA220	–	36	50	70	100	150
Circuit breaker	Icu (kA) for 440 V					
	F	N	H	S	F	L
GV3L32...66	50	–	–	–	–	–
NS80HMA	65	–	–	–	–	–
NSX100●MA100	–	35	50	65	90	130
NSX160●MA150	–	35	50	65	90	130
NSX250●MA220	–	35	50	65	90	130

(3) Composition of contactors:

LC1D25...D115: 3 poles + 1 NO auxiliary contact and 1 NC auxiliary contact.

LC1F185: 3 poles. To add auxiliary contacts or other accessories, please refer to the "Motor-starter solutions - Control and protection components" catalog.

(4) Replace ●● with the control circuit voltage reference indicated in the table below:

	Volts ~	24	48	110	220	230	240
		LC1D25...D115	50 Hz	B5	E5	F5	M5
	60 Hz	B6	E6	F6	M6	–	U6
	50/60 Hz	B7	E7	F7	M7	P7	U7
LC1F185	50 Hz (LX1 coil)	B5	E5	F5	M5	P5	U5
	60 Hz (LX1 coil)	–	E6	F6	M6	–	U6
	40...400 Hz (LX9 coil)	–	E7	F7	M7	P7	U7

For other voltages available between 24 V and 660 V, or a DC control circuit, please contact our Customer Care Centre.

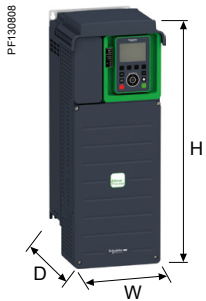
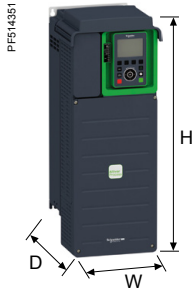

IP 21 drives: 200...240 V

Overall dimensions

Drive	W x H x D	
	mm	in.
ATV630D11M3	211 x 546 x 232	8.31 x 21.50 x 9.13
ATV630D15M3	226 x 673 x 271	8.90 x 26.50 x 10.67
ATV630D18M3	226 x 673 x 271	8.90 x 26.50 x 10.67
ATV630D22M3	226 x 673 x 271	8.90 x 26.50 x 10.67
ATV630D30M3	290 x 922 x 323	11.42 x 36.30 x 12.72
ATV630D37M3	290 x 922 x 323	11.42 x 36.30 x 12.72
ATV630D45M3	290 x 922 x 323	11.42 x 36.30 x 12.72

IP 21 drives: 380...480 V

Drive	W x H x D	
	mm	in.
ATV630D15N4	211 x 546 x 232	8.31 x 21.50 x 9.13
ATV630D18N4	211 x 546 x 232	8.31 x 21.50 x 9.13
ATV630D22N4	211 x 546 x 232	8.31 x 21.50 x 9.13
ATV630D30N4	226 x 673 x 271	8.90 x 26.50 x 10.67
ATV630D37N4	226 x 673 x 271	8.90 x 26.50 x 10.67
ATV630D45N4	226 x 673 x 271	8.90 x 26.50 x 10.67
ATV630D55N4	290 x 922 x 323	11.42 x 36.30 x 12.72
ATV630D75N4	290 x 922 x 323	11.42 x 36.30 x 12.72
ATV630D90N4	290 x 922 x 323	11.42 x 36.30 x 12.72

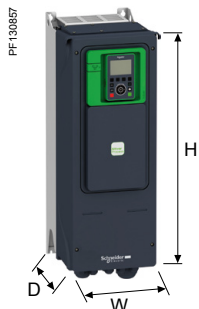

IP 55 drives: 380...480 V

Overall dimensions

Drive	W x H x D	
	mm	in.
ATV650D15N4	268 x 676 x 300	10.55 x 26.61 x 11.81
ATV650D18N4	268 x 676 x 300	10.55 x 26.61 x 11.81
ATV650D22N4	268 x 676 x 300	10.55 x 26.61 x 11.81
ATV650D30N4	290 x 910 x 340	11.42 x 35.83 x 13.39
ATV650D37N4	290 x 910 x 340	11.42 x 35.83 x 13.39
ATV650D45N4	290 x 910 x 340	11.42 x 35.83 x 13.39
ATV650D55N4	345 x 1250 x 375	13.58 x 49.21 x 14.76
ATV650D75N4	345 x 1250 x 375	13.58 x 49.21 x 14.76
ATV650D90N4	345 x 1250 x 375	13.58 x 49.21 x 14.76

IP 55 drives: 380...480 V with Vario disconnect switch

Drive	W x H x D	
	mm	in.
ATV650D15N4E	268 x 676 x 300	10.55 x 26.61 x 11.81
ATV650D18N4E	268 x 676 x 300	10.55 x 26.61 x 11.81
ATV650D22N4E	268 x 676 x 300	10.55 x 26.61 x 11.81
ATV650D30N4E	290 x 910 x 401	11.42 x 35.83 x 15.79
ATV650D37N4E	290 x 910 x 401	11.42 x 35.83 x 15.79
ATV650D45N4E	290 x 910 x 401	11.42 x 35.83 x 15.79
ATV650D55N4E	345 x 1250 x 436	13.58 x 49.21 x 17.17
ATV650D75N4E	345 x 1250 x 436	13.58 x 49.21 x 17.17
ATV650D90N4E	345 x 1250 x 436	13.58 x 49.21 x 17.17

Variable speed drives

Altivar Process

Passive filters

Passive filters: 400 V 50 Hz three-phase supply

Overall dimensions		
Passive filters	W x H x D	
	mm	in.
VW3A46105	232 x 436.11 x 247.5	9.13 x 17.17 x 9.74
VW3A46106	378 x 594.08 x 242	14.88 x 23.39 x 9.53
VW3A46107	378 x 594.08 x 242	14.88 x 23.39 x 9.53
VW3A46108	378 x 623.6 x 333	14.88 x 24.55 x 13.11
VW3A46109	378 x 623.6 x 333	14.88 x 24.55 x 13.11
VW3A46110	418 x 736.8 x 333	16.46 x 29.01 x 13.11
VW3A46111	418 x 736.8 x 333	16.46 x 29.01 x 13.11
VW3A46112	418 x 767.6 x 400	16.46 x 30.22 x 15.75
VW3A46113	418 x 767.6 x 400	16.46 x 30.22 x 15.75
VW3A46124	232 x 436.11 x 247.5	9.13 x 17.17 x 9.74
VW3A46125	378 x 594.08 x 242	14.88 x 23.39 x 9.53
VW3A46126	378 x 594.08 x 242	14.88 x 23.39 x 9.53
VW3A46127	378 x 623.6 x 333	14.88 x 24.55 x 13.11
VW3A46128	378 x 623.6 x 333	14.88 x 24.55 x 13.11
VW3A46129	418 x 736.8 x 333	16.46 x 29.01 x 13.11
VW3A46130	418 x 736.8 x 333	16.46 x 29.01 x 13.11
VW3A46131	418 x 767.6 x 400	16.46 x 30.22 x 15.75
VW3A46132	418 x 767.6 x 400	16.46 x 30.22 x 15.75

Passive filters: 480 V 60 Hz three-phase supply

Overall dimensions		
Passive filters	W x H x D	
	mm	in.
VW3A46143	232 x 436.11 x 247.5	9.13 x 17.17 x 9.74
VW3A46144	378 x 594.08 x 242	14.88 x 23.39 x 9.53
VW3A46145	378 x 594.08 x 242	14.88 x 23.39 x 9.53
VW3A46146	378 x 594.08 x 242	14.88 x 23.39 x 9.53
VW3A46147	378 x 623.6 x 333	14.88 x 24.55 x 13.11
VW3A46148	378 x 623.6 x 333	14.88 x 24.55 x 13.11
VW3A46149	418 x 736.8 x 333	16.46 x 29.01 x 13.11
VW3A46150	418 x 736.8 x 333	16.46 x 29.01 x 13.11
VW3A46151	418 x 767.6 x 400	16.46 x 30.22 x 15.75
VW3A46162	232 x 436.11 x 247.5	9.13 x 17.17 x 9.74
VW3A46163	378 x 594.08 x 242	14.88 x 23.39 x 9.53
VW3A46164	378 x 594.08 x 242	14.88 x 23.39 x 9.53
VW3A46165	378 x 594.08 x 242	14.88 x 23.39 x 9.53
VW3A46166	378 x 623.6 x 333	14.88 x 24.55 x 13.11
VW3A46167	378 x 623.6 x 333	14.88 x 24.55 x 13.11
VW3A46168	418 x 736.8 x 333	16.46 x 29.01 x 13.11
VW3A46169	418 x 736.8 x 333	16.46 x 29.01 x 13.11
VW3A46170	418 x 767.6 x 400	16.46 x 30.22 x 15.75

Additional EMC input filters

Overall dimensions

EMC filters	W x H x D	
	mm	in.
VW3A4703	80 x 290 x 140	3.15 x 11.42 x 5.51
VW3A4704	90 x 300 x 160	3.54 x 11.81 x 6.30
VW3A4705	100 x 330 x 180	3.94 x 12.99 x 7.09
VW3A4706	130 x 350 x 190	5.12 x 13.78 x 7.48
VW3A4707	140 x 400 x 230	5.51 x 15.75 x 9.06
VW3A4708	230 x 450 x 320	9.06 x 17.72 x 12.60

dv/dt filters

Overall dimensions

dv/dt filters	W x H x D	
	mm	in.
VW3A5304	520 x 220 x 295	20.47 x 8.66 x 11.61
VW3A5305	540 x 220 x 295	21.26 x 8.66 x 11.61
VW3A5306	350 x 255 x 350	13.78 x 10.03 x 13.78

Sinus filters

Overall dimensions

Sinus filters	W x H x D	
	mm	in.
VW3A5404	295 x 520 x 220	11.61 x 20.47 x 8.66
VW3A5405	295 x 710 x 220	11.61 x 27.95 x 8.66
VW3A5406	430 x 495 x 330	16.93 x 19.49 x 12.99

490NTC00005	26	ATV650D90N4	14	VW3A46144	33
	27	ATV650D90N4E	15	VW3A46145	33
490NTC00005U	26			VW3A46146	33
	27	L		VW3A46147	33
490NTC00015	26	LU9AD7	30	VW3A46148	33
	27	LU9GC3	17	VW3A46149	33
490NTC00015U	26		26	VW3A46150	33
	27			VW3A46151	33
490NTW00002	26	T		VW3A46162	33
	27	TCSCAR01NM120	29	VW3A46163	33
490NTW00002U	26	TCSCAR013M120	28	VW3A46164	33
	27	TCSXCNAMUM3P	17	VW3A46165	33
490NTW00005	26	TSXCANCA50	28	VW3A46166	33
	27	TSXCANCA100	28	VW3A46167	33
490NTW00005U	26	TSXCANCA300	28	VW3A46168	33
	27	TSXCANCADD1	29	VW3A46169	33
490NTW00012	26	TSXCANCADD03	29	VW3A46170	33
	27	TSXCANCB50	28	VW3A4703	35
490NTW00012U	26	TSXCANCB100	28	VW3A4704	35
	27	TSXCANCB300	28	VW3A4705	35
A		TSXCANCBDD3	29	VW3A4706	35
ATV630D11M3	12	TSXCANCBDD5	29	VW3A4707	35
	38	TSXCANCD50	28	VW3A4708	35
ATV630D15M3	12	TSXCANCD100	28	VW3A47903	35
	38	TSXCANCD300	28	VW3A47904	35
ATV630D15N4	13	TSXCANKCDF180T	28	VW3A47905	35
	39	TSXCANTDM4	29	VW3A47906	35
ATV630D18M3	12			VW3A47907	35
	38	V		VW3A47908	35
ATV630D18N4	13	VW3A1104R10	17	VW3A5304	36
	39	VW3A1104R30	17	VW3A5305	36
ATV630D22M3	12	VW3A1104R50	17	VW3A5306	36
	38	VW3A1104R100	17	VW3A53904	36
ATV630D22N4	13	VW3A1111	16	VW3A53905	36
	39	VW3A1112	17	VW3A5404	37
ATV630D30M3	12	VW3A1115	17	VW3A5405	37
	38	VW3A3203	23	VW3A5406	37
ATV630D30N4	13	VW3A3204	23	VW3A54904	37
	39	VW3A3607	30	VW3A54905	37
ATV630D37M3	12	VW3A3608	28	VW3A8306R03	17
	38	VW3A3609	31		26
ATV630D37N4	13	VW3A3618	28	VW3A8306R10	17
	39	VW3A3627	30		26
ATV630D45M3	12	VW3A3628	29	VW3A8306R30	17
	38	VW3A3720	27		26
ATV630D45N4	13	VW3A46105	32	VW3A8306RC	17
	39	VW3A46106	32		26
ATV630D90N4	13	VW3A46107	32	VW3A8306TF03	17
	39	VW3A46108	32		26
ATV650D15N4	14	VW3A46109	32	VW3A8306TF10	17
ATV650D15N4E	15	VW3A46110	32		26
ATV650D18N4	14	VW3A46111	32	VW3CANCARR1	28
ATV650D18N4E	15	VW3A46112	32	VW3CANCARR03	28
ATV650D22N4	14	VW3A46113	32	VW3CANTAP2	29
ATV650D22N4E	15	VW3A46124	32	VX5VP50A001	15
ATV650D30N4	14	VW3A46125	32	VX5VP50BC001	15
ATV650D30N4E	15	VW3A46126	32	VX5VPS3001	15
ATV650D37N4	14	VW3A46127	32	VX5VPS4001	15
ATV650D37N4E	15	VW3A46128	32	VX5VPS5001	15
ATV650D45N4	14	VW3A46129	32		
ATV650D45N4E	15	VW3A46130	32	Z	
ATV650D55N4	14	VW3A46131	32	ZB5AZ905	17
ATV650D55N4E	15	VW3A46132	32		
ATV650D75N4	14	VW3A46143	32		
ATV650D75N4E	15	VW3A46144	33		

Schneider Electric Industries SAS

Head Office
35, rue Joseph Monier
F-92500 Rueil-Malmaison
France

www.schneider-electric.com

The information provided in this documentation contains general descriptions and/or technical characteristics of the performance of the products contained herein. This documentation is not intended as a substitute for and is not to be used for determining suitability or reliability of these products for specific user applications. It is the duty of any such user or integrator to perform the appropriate and complete risk analysis, evaluation and testing of the products with respect to the relevant specific application or use thereof. Neither Schneider Electric nor any of its affiliates or subsidiaries shall be responsible or liable for misuse of the information contained herein.

Design: Schneider Electric
Photos: Schneider Electric
Printed by:

DIA2ED2140502EN

May 2014